

*hatria*

COLLECTIONS 5.0

## INDEX

G-FULL	10
ABITO	18
SCULTURE	30
DOLCEVITA	38
GRANDANGOLO	46
AREA	54
FUSION	60
HAPPY HOUR	68
LE FIABE	80
DAYTIME EVO / DAYTIME	94
NIDO	102
ERIKA pro / ERIKA pro Q	108
YOU & ME	116
LIF showertrays	122
SLIDING wood system	132
pro come PROGETTO	140

## COLLECTIONS 5.0



**THE BATHROOM I WOULD LIKE**

---

DAS BADEZIMMER MEINER TRÄUME  
LA SALLE DE BAINS COMME JE LA VOUDRAIS  
EL BAÑO QUE DESEO  
БАННАЯ МОЕЙ МЕЧТЫ

**IL BAGNO,  
COME LO VORREI**





“  ”  
Ceramics of Italy



UNI EN ISO 9001:2008



SISTEMA DI GESTIONE  
QUALITÀ CERTIFICATO

CERTIQUALITY  
È MEMBRO DELLA  
FEDERAZIONE CISO



4,5 lt

*hatria*



## CAREFULLY DESIGNED, SUSTAINABLE QUALITY

---

EINE GEPLANTE, NACHHALTIGE QUALITÄT

UNE QUALITÉ VOLONTAIRE ET DURABLE

UNA CALIDAD PLANIFICADA Y SOSTENIBLE

ЭКОЛОГИЧЕСКИ БЕЗОПАСНОЕ И ЗАПРОЕКТИРОВАННОЕ КАЧЕСТВО

# UNA QUALITÀ PROGETTATA E SOSTENIBILE

Design innovativo e produzione rigorosamente Made in Italy, caratterizzano l'offerta di Hatria, azienda presente sul mercato dagli anni '70. La tradizione lascia spazio all'innovazione proiettando l'azienda verso mercati internazionali, grazie ad una offerta ampia e diversificata di soluzioni che incontrano il gusto di un pubblico eterogeneo, attento alla qualità e al design dei prodotti. La certificazione del Sistema Qualità Hatria da parte del Certiquality-Certichim, secondo la norma UNI-EN-ISO 9001:2008, è un'ulteriore passo volto a garantire la massima performance dei nostri prodotti.

The Hatria range, present on the market for over 20 years, is marked by innovative design and strictly Italian-made production. Tradition makes way for innovation, and the company looks to the international market with a wide, diversified range of solutions that satisfy the tastes of a varied audience paying attention to quality and design. The certification of the Hatria Quality System on the part of Certiquality-Certichim, in accordance with the UNI-EN-ISO 9001:2008 standard, is a further step towards guaranteeing top product performance.

Ein innovatives Design und eine ausschließlich in Italien ansässige Produktion zeichnen das Angebot von Hatria aus, die seit mehr als 20 Jahren auf dem Markt ist. Die Tradition lässt Raum für die Innovation und bereitet die Firma dank eines breiten, diversifizierten Angebots an Lösungen, die dem Geschmack eines verschiedenartigen, auf die Qualität und das Design der Produkte bedachten Publikums gerecht werden, auf internationale Märkte vor. Die Zertifizierung des Qualitätsmanagementsystems von Hatria durch Certiquality-Certichim gemäß Norm UNI-EN-ISO 9001:2008 ist ein weiterer Schritt, um zu garantieren, dass unsere Produkte die beste Leistung bieten.

Un design novateur et une production rigoureusement Made in Italy caractérisent l'offre d'Hatria, est sur le marché depuis plus de 20 ans. La tradition laisse une place à l'innovation tout en orientant l'entreprise vers des marchés internationaux, grâce à une offre large et diversifiée de solutions qui rencontrent le goût d'un public hétérogène, attentif à la qualité et au design des produits. La certification du Système Qualité de conformité à la norme UNI-EN-ISO 9001:2008, que le Certiquality-Certichim a remise à Hatria, est un gage supplémentaire de l'excellence de nos produits.

La oferta de Hatria, empresa presente en el mercado desde hace más de 20 años, se caracteriza por su diseño innovador y una producción hecha exclusivamente en Italia. La tradición deja espacio a la innovación proyectando la empresa hacia mercados internacionales, gracias a una oferta dilatada y diversificada de soluciones que satisfacen el gusto de un público heterogéneo, interesado en la calidad y en el diseño de los productos. La certificación del Sistema de Calidad de Hatria por parte de Certiquality-Certichim, según la norma UNI-EN-ISO 9001:2008, es otro paso adelante destinado a garantizar el rendimiento máximo de nuestros productos.

Новаторский дизайн и производство исключительно «Made in Italy» характеризуют предложение компании Hatria - это компания, которая известна на рынке более 20-ти лет. Традиции уступают место инновациям, открывая для фирмы международные рынки, благодаря широкой и диверсифицированной гамме решений, способных удовлетворить вкусам неоднородной публики, обращающей внимание на качество и дизайн продукции. Сертификация Системы Качества Hatria на соответствие требованиям стандартов UNI-EN-ISO 9001:2008, проведенная Институтом Certiquality-Certichim, – это дальнейший шаг, направленный на обеспечение максимально высокого качества нашей продукции.

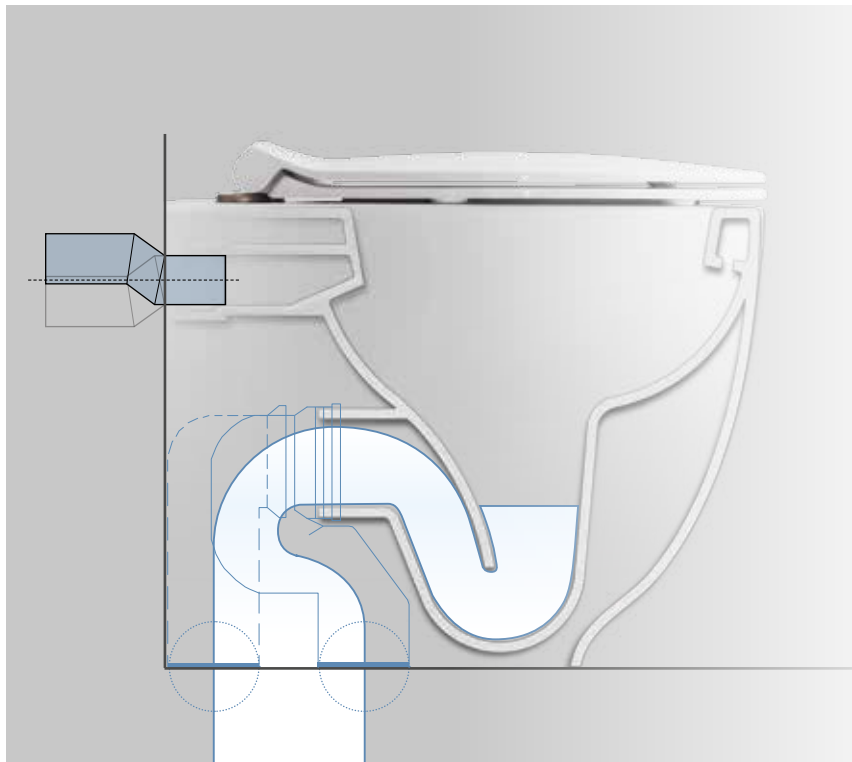



## DESIGN FOLLOWING THE CONTOURS OF INNOVATION

---

DAS DESIGN PASST SICH DEN FORMEN DER INNOVATION AN  
LE DESIGN ÉPOUSE LES FORMES DE L'INNOVATION  
EL DISEÑO SIGUE LA FORMA DE LA INNOVACIÓN  
ДИЗАЙН СЛЕДУЕТ ЗА ИННОВАЦИОННЫМИ ФОРМАМИ

# IL DESIGN SEGUE LE FORME DELL'INNOVAZIONE

Un'idea di progetto a 360° è alla base della ricerca Hatria, che continuamente si evolve per offrire nuove soluzioni coniugando estetica e funzionalità: il design costruisce la forma intorno a sistemi che migliorano la qualità e le performances del prodotto. **PURE FIX®**, il nuovo fissaggio nascosto per vasi e bidet terra filo muro, presente nell'ultima collezione Hatria Le Fiabe, è l'innovazione che permette di avere finalmente anche per i sanitari terra un risultato esteticamente perfetto e pulito, in quanto privi di alcun fissaggio visibile. In combinazione con il **VASO TRASLATO** e il **BIDET APERTO** nella parte posteriore, ideali nelle ristrutturazioni per adattare impianti esistenti.

A 360° project idea lies at the base of Hatria research, which is evolving all the time to offer new solutions that are both beautiful and functional: design builds the shape around systems conceived to improve product quality and performance. **PURE FIX®**, the new concealed fixing element for back-to-wall WCs and bidets, presented in the latest Hatria collection, "Le Fiabe", is an innovative solution that offers a perfectly attractive, clean solution for back-to-wall bathroom fittings, because there are no visible fixing elements. In combination with the **SHIFTED WC** and the **BIDET OPEN** at the back, it is ideal for renovations, to adapt existing fittings.

Eine Projektidee, die alle Aspekte einbezieht, bildet die Grundlage für die Forschung von Hatria, die sich ständig weiterentwickelt, um neue Lösungen unter Kombination der Ästhetik und der Zweckmäßigkeit zu bieten. Das Design stellt die Form rund um Systeme dar, die die Qualität und die Leistungen des Produkts verbessern. **PURE FIX®**, die neue verborgene Befestigung für an die Wand anliegende Stand-Klosettbecken und -Bidets der neuen Kollektion „Le Fiabe“ von Hatria, ist die Innovation, dank der endlich auch die auf dem Boden stehenden sanitären Anlagen ein perfektes, sauberes ästhetisches Ergebnis ohne sichtbare Befestigungen bieten können. In Kombination mit dem **KLOSETTBECKEN MIT VERSETZTEM ABFLUSS** und dem hinten **OFFENEN BIDET** ist es ideal, um im Zuge von Renovierungen an bestehende Anlagen angepasst zu werden.

Une idée de projet à 360° est à la base de la recherche Hatria qui ne cesse d'évoluer pour pouvoir proposer de nouvelles solutions alliant esthétique et fonctionnalité. Le design construit la forme autour de systèmes qui concourent à améliorer la qualité et les performances du produit. **PURE FIX®**, le nouveau système de fixation de sol invisible pour cuvettes de WC et bidets au ras du mur fait partie de la dernière collection d'Hatria « Le Fiabe ». C'est l'innovation qui permet finalement d'avoir des sanitaires au sol avec un résultat esthétiquement parfait et propre, puisqu'aucun système de fixation n'est visible. Combiné avec la **CUVETTE DÉCALÉE** et le **BIDET OUVERT** dos au mur, il est l'idéal dans les rénovations pour adapter les installations déjà existantes.

La investigación de Hatria, que parte de una idea de proyecto 360°, evoluciona constantemente para ofrecer nuevas soluciones que combinen estética y eficiencia; el diseño crea la forma en torno a sistemas que mejoran la calidad y el rendimiento del producto. **PURE FIX®**, la nueva fijación invisible para inodoros y bidés de tierra y contra la pared, presente en la última colección de Hatria "Le Fiabe", es la innovación que permite que sanitarios de tierra también dispongan finalmente de un resultado estéticamente perfecto y limpio sin fijaciones visibles. Junto con el **INODORO VARIABLE** y el **BIDÉ ABIERTO** en su parte posterior, es ideal en reestructuraciones para adaptar instalaciones ya existentes.

Идея проекта на 360° лежит в основе научно-исследовательской работы компании Hatria, которая постоянно развивается, чтобы предложить новые решения, объединив эстетику и функциональность: дизайн создает форму систем, которые улучшают качество и достоинства продукта. **PURE FIX®** – это новая скрытая система монтажа приставных биде и унитазов, представленная в новой коллекции "Le Fiabe" компании Hatria. Являясь инновационной, она позволяет, наконец-то, идеально и чисто устанавливать наполную сантехнику без каких-либо видимых крепежных устройств. Сочетание **УНИТАЗА С ПЕРЕНОСНЫМ ВЫПУСКОМ** и **ОТКРЫТОГО** в задней части **БИДЕ** будет идеальным для проведения ремонтных работ с целью установки их в уже существующую систему.



## **PURE RIM®\_MORE HYGIENE, LESS WATER, ZERO BACTERIA**

---

PURE RIM®\_MEHR HYGIENE, WENIGER WASSER, NULL BAKTERIEN

PURE RIM®\_HYGIÈNE OPTIMALE, MOINS D'EAU CONSOMMÉE, ZÉRO BACTÉRIE

PURE RIM®\_MÁS HIGIENE, MENOS AGUA, CERO BACTERIAS

PURE RIM®\_БОЛЬШЕ ГИГИЕНЫ, МЕНЬШЕ ВОДЫ, НОЛЬ БАКТЕРИЙ

# **PURE RIM®** *rimless wc collection*

## **PIÙ IGIENE, MENO ACQUA, ZERO BATTERI**

I nuovi vasi sospesi rimless FUSION, LE FIABE, ERIKA pro di Hatria grazie al sistema di risciacquo con bordo a vista, utilizzando soltanto una piccola quantità d'acqua, non presentano zone di deposito sporco e formazione di batteri. La pulizia del sanitario risulta così estremamente semplice e veloce. Realizzati secondo un concetto innovativo del sistema di scarico, per facilitare le operazioni di pulizia e manutenzione, questi vasi sospesi in ceramica senza brida mantengono comunque invariate le caratteristiche di installazione dei tradizionali vasi. Lo scarico ed una perfetta pulizia sono garantiti con soli 4,5/3 litri d'acqua.

The new Hatria rimless wall hung WCs FUSION, LE FIABE, ERIKA pro flushing systems come with visible edges and use only a small amount of water, leaving no space for dirt and bacteria to form. This makes it extremely quick and easy to clean. Designed with an innovative flushing system that facilitates cleaning and maintenance, these ceramic wall hung rimless WCs are in any case installed in the same way as conventional WCs. Flushing and perfect cleaning are assured with just 4.5/3 litres of water.

Die neuen hänge Klosetts rimless FUSION, LE FIABE, ERIKA pro von Hatria benötigen dank des Spülsystems mit sichtbarem Rand nur eine geringe Wassermenge, lagern keinen Schmutz ab und fördern die Bakterienbildung nicht. Die Reinigung der Sanitäranlage ist daher extrem einfach und schnell. Diese nach einem innovativen Spülanlagenkonzept, das die Reinigung und Wartung erleichtert, produzierten spülrandlosen wandhängenden Klosetts aus Keramik behalten in jedem Fall die Installationseigenschaften von traditionellen Klosetts bei. Die Spülung und eine perfekte Reinigung werden mit nur 4,5/3 Litern Wasser gewährleistet.

Grâce au système de rinçage à bride ouverte qui ne consomme qu'un petit volume d'eau, dans les nouvelles cuvettes suspendu rimless Hatria FUSION, LE FIABE, ERIKA pro, les salissures ne forment plus de dépôt, de sorte que les bactéries ne peuvent plus s'y loger. La cuvette est ainsi plus facile et plus rapide à nettoyer. Dotées de cette technique de rinçage innovante qui facilite les opérations de nettoyage et d'entretien, ces cuvettes suspendues sans bride s'installent exactement comme des cuvettes traditionnelles. L'efficacité du rinçage et une propreté parfaite sont assurées avec 4,5/3 litres d'eau seulement.

Gracias al sistema de lavado con borde accesible, los nuevos inodoros suspendidos rimless FUSION, LE FIABE, ERIKA pro de Hatria no presentan zonas de depósito de suciedad ni formación de bacterias con solo usarse un poco de agua. La limpieza del inodoro resulta por tanto extremadamente simple y rápida. Hechos según un concepto innovador del conducto de desagüe, para facilitar las operaciones de limpieza y mantenimiento, estos inodoros suspendidos en cerámica sin canal de lavado mantienen igualmente todas las características de instalación de los inodoros tradicionales. El desagüe y una perfecta limpieza se garantizan con solo 4,5/3 litros de agua.

Новые подвесной унитазы rimless FUSION, LE FIABE, ERIKA pro производства Hatria, благодаря системе ополаскивания с открытым бортиком, используют минимальное количество воды и препятствуют образованию грязных отложений и формированию бактерий. Уборка такой сантехники становится исключительно простой и быстрой. Изготовленные по инновационной концепции системы слива, что существенно облегчает их очистку и содержание, эти керамические подвесные унитазы без бортика сохраняют неизменными монтажные характеристики традиционных унитазов. Слив и абсолютная чистота обеспечиваются всего лишь 4,5/3 литрами воды.



**SPAZIO, TEMPO E FUNZIONI  
SI FONDONO IN UN NUOVO COMFORT**

---

SPACE, TIME AND FUNCTIONALITY  
BLEND TOGETHER TO CREATE  
A NEW CONCEPT IN COMFORT

**G-FULL**



01



02

01: G-FULL 140 VASO A DESTRA COPERTURA NOCE, MOBILI SLIDING WOOD SYSTEM

02: G-FULL 140 VASO A SINISTRA COPERTURA BIANCA, PANCA AD L

03: G-FULL 140 VASO A SINISTRA COPERTURA BIANCA,  
PANCA AD L, PILOZZI DA APPOGGIO.

01: G-Full 140 wc right nut cover, furniture SLIDING wood system

02: G-Full 140 wc left white cover, L bench,

03: G-Full 140 wc left white cover,  
L bench, surface nounted sinks.





04





04: G-FULL 140 VASO A DESTRA COPERTURA WENGÈ  
MOBILI SLIDING WOOD SYSTEM

*04: G-Full 140 wc right wengè cover  
Furniture SLIDING wood system*





05: G-FULL 120 VASO A DESTRA COPERTURA IROKO  
06: PILOZZO SOSPESO

07: G-FULL 120 SOLO VASO A DESTRA  
08: G-FULL 120 VASO A DESTRA CON PILOZZO

*05: G-Full 120 wc right wood iroko cover*

*06: wall hung sink*

*07: G-Full 120 wc right only*

*08: G-Full 120 wc right with sink*





**UN NUOVO ABITO  
PER IL BAGNO CONTEMPORANEO**

---

A NEW OUTFIT FOR THE  
CONTEMPORARY BATHROOM

**ABITO**





**BIANCO / WHITE**

01-03: VASO E BIDET SOSPESI  
02: LAVABO 58 D'APPOGGIO

*01-03: wall hung wc and bidet  
02: surface-mounted washbasin 58*



04

#### **ONDE GRIGIO**

04: LAVABO 100 SOSPESO  
05: VASO E BIDET SOSPESI

*04: wall hung washbasin 100  
05: wall hung wc and bidet*





05





07

**ROSA ANTICO / OLD ROSE**

06: VASO E BIDET SOSPESI  
07: LAVABO 58 D'APPOGGIO

*06: wall hung wc and bidet  
07: surface-mounted washbasin 58*



08



**VERDE NOTTE / NIGHT GREEN**

08: LAVABO 58 D'APPOGGIO, VASO + BIDET SOSPESI

*08: surface-mounted washbasin 58, wall hung wc and bidet*





**NERO / BLACK**

09: VASO E BIDET SOSPESI  
10: LAVABO 58 D'APPOGGIO

**NERO / BLACK RIGHE ORO**

11: VASO E BIDET SOSPESI

**RIGHE ORO**

12: VASO E BIDET SOSPESI

*09-11-12: wall hung wc and bidet  
10: surface-mounted washbasin 58*







**PROTAGONISTA  
UN'ELEGANZA SENZA TEMPO**

---

THE PICTURE OF  
TIMELESS ELEGANCE

**SCULTURE**



01

01: LAVABO 110 CON SEMICOLONNA

*01: washbasin 110 with siphon cover*



02: VASO + BIDET FILO MURO  
03: LAVABO 77 CON SEMICOLONNA

*02: back to wall wc + bidet  
03: washbasin 77 with siphon cover*





04: LAVABO 65 CON SEMICOLONNA, VASO MONOBLOCCO CON CASSETTA

*04: washbasin 65 with siphon cover, coupled wc with cistern*



05: VASO + BIDET SOSPESI, LAVABO 110 CON COLONNA

*05 wall hung wc + bidet, washbasin 110 with pedestal*



06: LAVABO FREESTANDING 65 BIANCO, PORTALE BIANCO, VASO + BIDET SOSPESI BIANCO  
07: LAVABO FREESTANDING 65 BIANCO, PORTALE BIANCO

*06: freestanding white washbasin 65, white furniture, wall hung white wc + bidet  
07: freestanding white washbasin 65, white furniture*







**COMBINAZIONE TRA  
CLASSICO E CONTEMPORANEO**

---

COMBINATION OF  
CLASSIC AND CONTEMPORARY

**DOLCEVITA**



01

01: LAVABO 650x480 DA INCASSO

*01: built-in washbasin 650x480*



02

02: LAVABO R75 CON COLONNA

*02: washbasin R75 with pedestal*



03



03: VASO + BIDET, LAVABO O 75 CON COLONNA

*03: wc + bidet, washbasin O 75 with pedestal*



04



05



06

04: LAVABO 70 CON COLONNA  
 05: VASO CON CASSETTA A ZAINO + BIDET  
 06: VASO CON CASSETTA A ZAINO EDIZIONE BRONZO + BIDET

*04: washbasin 70 with pedestal  
 05: wc with low-level cistern+ bidet  
 06: wc with low-level cistern bronze edition + bidet*

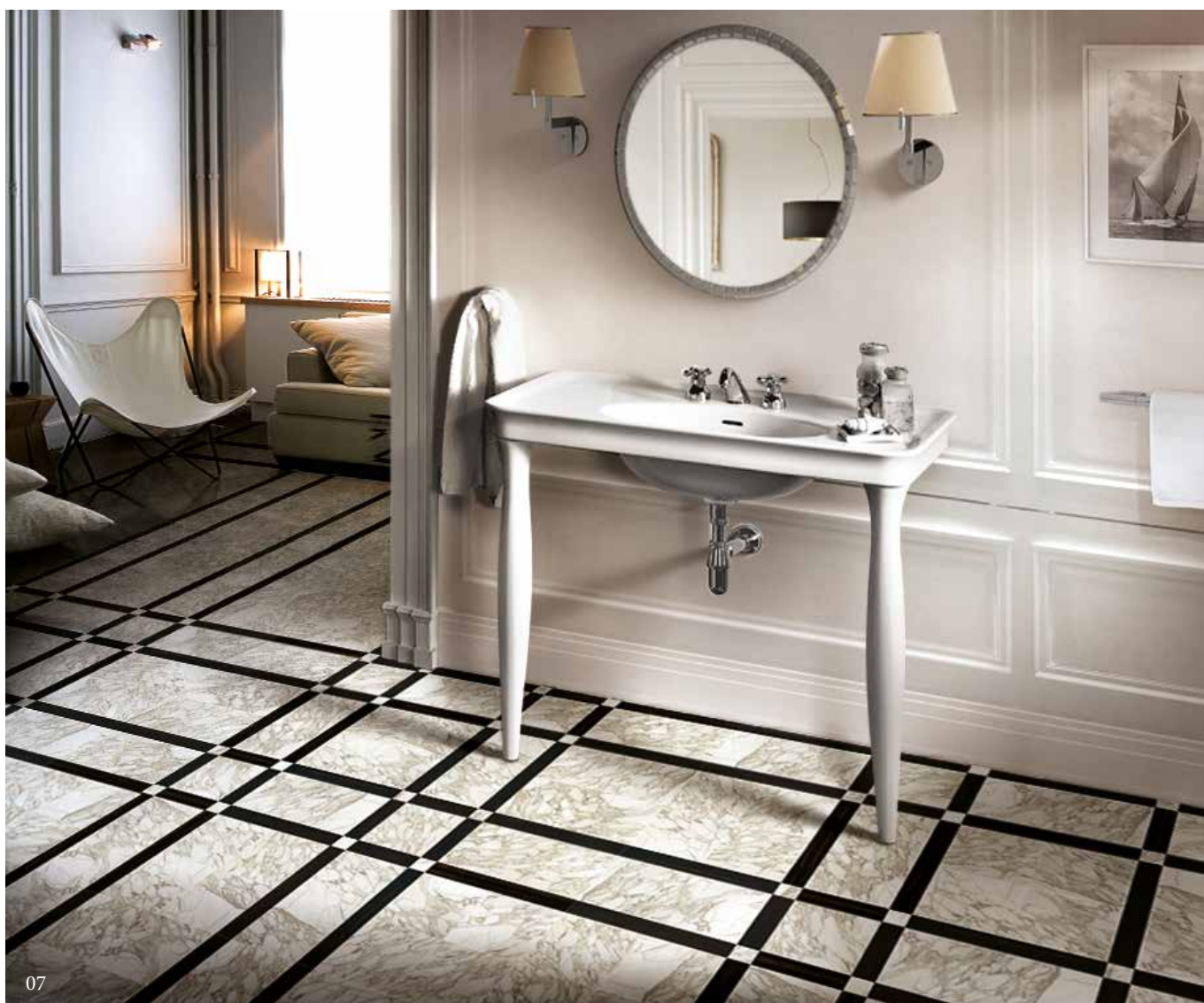

07

07: LAVABO 100 CON GAMBE

*07: washbasin 100 with legs*







**IL BAGNO  
CAMBIA PROSPETTIVA**

---

A BATHROOM  
TO INSPIRE THE DIMENSION

**GRANDANGOLO**





02

01: LAVABO G-150  
02: LAVABO G-130 T SINISTRO  
MOBILI SLIDING WOOD SYSTEM

---

*01: washbasin G-150  
02: washbasin G-130 T left  
Furniture SLIDING wood system*



03



03: LAVABO G-130, MOBILI SLIDING WOOD SYSTEM, VASO + BIDET FUSION

*03: washbasin G-130, furniture SLIDING wood system, wc + bidet FUSION*



04



05



06

04: LAVABO G-75 SINISTRO - DESTRO  
 05: LAVABO G-50 DESTRO  
 06: LAVABO G-75 DESTRO  
 MOBILI SLIDING WOOD SYSTEM

*04: washbasin G-75 left - right  
 05: washbasin G-50 right  
 06: washbasin G-75 right  
 Furniture SLIDING wood system*



07

07: LAVABO G-100  
MOBILI SLIDING WOOD SYSTEM

07: washbasin G-100  
Furniture SLIDING wood system







**UN SISTEMA DI EQUILIBRI  
TRA FORME E SPAZI**

A SYSTEM OF BALANCES  
BETWEEN FORMS AND SPACES

AREA



01: LAVABO 90x45  
02: LAVABO 80x35 D'APPOGGIO

---

01: washbasin 90x45  
02: surface-mounted washbasin 80x35



03



04



05

03: LAVABI 81x45  
 04: LAVABO 100x35 D'APPOGGIO  
 05: LAVABI 60x45 CON SEMICOLONNA

03: washbasins 81x45  
 04: surface-mounted washbasin 100x35  
 05: washbasins 60x45 with siphon cover



06: LAVABO 90x35

06: washbasin 90x35



07



08

07: LAVABO 100x35  
08: LAVABI 70x35

07: washbasin 100x35  
08: washbasins 70x35





**FORME CONTINUE  
PER SPAZI FLESSIBILI**

---

ENDLESS FORMS FOR  
FLEXIBLE SPACES

**FUSION**



## FUSION

- 01: VASO + BIDET SOSPESI
- 02: VASO FILO MURO + MONOLITH
- 03: VASO + BIDET FILO MURO

---

*01: wall hung wc + bidet*  
*02: back to wall wc + MONOLITH*  
*03: back to wall wc + bidet*





03



04

### FUSION Q

04: VASO + BIDET SOSPESI

*04: wall hung wc + bidet*



05



06



07

### FUSION

05: ORINATOIO CON FOTOCELLULA

06: ORINATOIO

07: ORINATOIO CON COPERCHIO

---

*05: urinal with photocell*

*06: urinal*

*07: urinal with cover*



08

**FUSION 48**

08: VASO + BIDET FILO MURO

*08: back to wall wc + bidet*



**FUSION 48**

09: VASO + BIDET SOSPESI

*09: wall hung wc + bidet*





**DESIGN E PERSONALITÀ  
PER OGNI ORA**

DESIGN AND PERSONALITY  
FOR EVERY HOUR

**HAPPY HOUR**







### TRILOGY

- 01: HAPPY HOUR 07:00 ORO BIANCO
- 02: HAPPY HOUR 07:00 ORO GIALLO
- 03: HAPPY HOUR 07:00 ORO ROSSO

- 
- 01: HAPPY HOUR 07:00 white gold*
  - 02: HAPPY HOUR 07:00 yellow gold*
  - 03: HAPPY HOUR 07:00 red gold*





05

04: HAPPY HOUR 07:00  
05: HAPPY HOUR 11:00

---



06: HAPPY HOUR 07:00 ROSA ANTICO BICOLOR  
07: HAPPY HOUR 07:00 VERDE NOTTE BICOLOR

*06: HAPPY HOUR 07:00 OLD ROSE bicolor  
07: HAPPY HOUR 07:00 NIGHT GREEN bicolor*



08: HAPPY HOUR 11:00 ROSA ANTICO BICOLOR  
09: HAPPY HOUR 11:00 VERDE NOTTE BICOLOR

*08: HAPPY HOUR 11:00 OLD ROSE bicolor  
09: HAPPY HOUR 11:00 NIGHT GREEN bicolor*



10



11

10: HAPPY HOUR 07:15  
11: HAPPY HOUR 11:15

---



12: HAPPY HOUR 10:00  
13: HAPPY HOUR 17:00



14

14: HAPPY HOUR 03:00





15: HAPPY HOUR 02:00  
16: HAPPY HOUR 22:00  
17: HAPPY HOUR 09:00  
18: HAPPY HOUR 09:30



**IMMERGERSI IN UN LUOGO MAGICO  
CHE LASCIA SPAZIO ALL'IMMAGINAZIONE**

---

LOSE YOURSELF IN A MAGICAL WORLD  
THAT LEAVES ROOM FOR IMMAGINATION

**LE FIABE**





02



03



04

01: VASO + BIDET SOSPESI  
 02-03: LAVABO 80  
 04: LAVABO 80, MOBILE NOCE - CASSETTO NOCE  
 MOBILI SLIDING WOOD SYSTEM

*01: wall hung wc + bidet  
 02-03: washbasin 80  
 04: washbasin 80, nut furniture - nut drawer  
 Furniture SLIDING wood system*





05: LAVABO 80, VASO + BIDET SOSPESI, MOBILI SLIDING WOOD SYSTEM

*05: washbasin 80, wall hung wc + bidet, furniture SLIDING wood system*







06: LAVABO 80, MOBILE WENGÈ - CASSETTO BIANCO  
07-08: VASO + BIDET FILO MURO  
MOBILI SLIDING WOOD SYSTEM

*06: washbasin 80, wengè furniture - white drawer  
07-08: back to wall wc + bidet  
Furniture SLIDING wood system*





09: LAVABO 100  
10: LAVABO 100, MOBILE WENGÈ  
11: DOPPIO LAVABO 60

*09: washbasin 100  
10: washbasin 100, wengè furniture  
11: double washbasin 60*





12: LAVABO 60, VASO E BIDET 50 SOSPESI  
13: VASO E BIDET 50 SOSPESI

*12: wall hung washbasin 60, wall hung wc and bidet 50  
13: wall hung wc and bidet 50*



14-15: VASO E BIDET 50 FILO MURO  
16: LAVABO 60, MOBILE BIANCO + VASO E BIDET 60 FILO MURO

*14-15: back to wall wc and bidet 50  
16: washbasin 60, white furniture + back to wall wc and bidet 50*







**SPAZI DEL VIVERE  
CONTEMPORANEO**

---

CONTEMPORARY  
LIVING SPACES

**DAYTIME  
DAYTIME EVO**



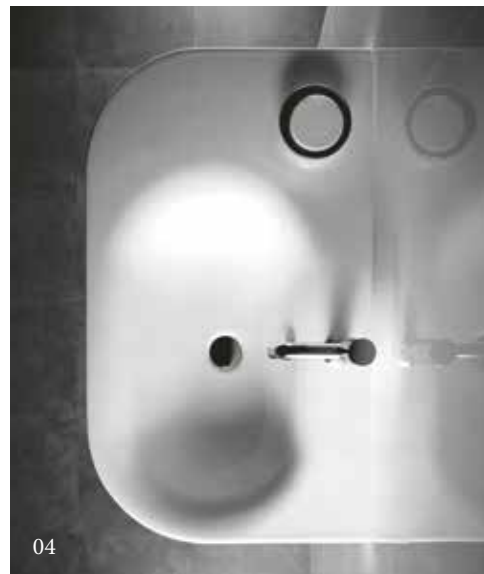

**DAYTIME**

01: LAVABO 70

02: LAVABO 110

03: LAVABI 86 DESTRO / SINISTRO

04: LAVABO 86 DESTRO

*01: washbasin 70*

*02: washbasin 110*

*03: washbasins 86 right / left*

*04: washbasin 86 right*



05



06



07

**DAYTIME**

- 05: LAVABI 55 CON SEMICOLONNA
- 06: LAVABO 62 INCASSO
- 07: LAVABO 62 CON SEMICOLONNA

- 
- 05: washbasins 55 with siphon cover*
  - 06: built in washbasin 62*
  - 07: washbasin 62 with siphon cover*



**DAYTIME**

- 08: VASO + BIDET SOSPESI
- 09: VASO + BIDET FILO MURO

---

*08: wall hung wc + bidet*  
*09: back to wall wc + bidet*





11

### **DAYTIME EVO**

10: VASO + BIDET FILO MURO

11: VASO MONOBLOCCO CON CASSETTA

---

*10: back to wall wc + bidet*

*11: coupled wc with cistern*







**LINEE MORBIDE E DELICATE  
PER IL TUO BAGNO**

---

SMOOTH AND DELICATE LINES  
FOR YOUR BATHROOM

**NIDO**





- 01: LAVABO 62 CON COLONNA
- 02: LAVABO 56 CON SEMICOLONNA
- 03: LAVABI 68
- 04: LAVABO 75 D'APPOGGIO

- 01: washbasin 62 with pedestal*
- 02: washbasin 56 with siphon cover*
- 03: washbasins 68*
- 04: surface-mounted washbasin 75*



05: VASO + BIDET FILO MURO  
06: VASO + BIDET

*05: back to wall wc + bidet  
06: wc + bidet*



07



08



09

- 07: VASO + BIDET SOSPESI  
08: VASO MONOBLOCCO CON CASSETTA  
09: VASO FILO MURO + MONOLITH

---

*07: wall hung wc + bidet  
08: coupled wc with cistern  
09: back to wall wc + MONOLITH*



**DESIGN E FUNZIONALITÀ  
NEL PROGETTO**

---

DESIGN AND FUNCTIONALITY  
FOR YOUR PROJECTS

ERIKA pro Q  
ERIKA pro



**ERIKA pro Q**

- 01: LAVABO 120 DOPPIO BACINO CON SEMICOLONNA
- 02: LAVABO 100 CON SEMICOLONNA
- 03: LAVABO 65 CON COLONNA

- 01: double washbasin 120 with siphon cover*
- 02: washbasin 100 with siphon cover*
- 03: washbasin 65 with pedestal*





04



05



06

**ERIKA pro Q**

- 04: LAVABO 80, MOBILE WENGÈ
- 05: LAVABO 80, MOBILE NOCE
- 06: LAVABO 80, MOBILE BIANCO LUCIDO

---

*04: washbasin 80, wengè furniture*  
*05: washbasin 80, nut furniture*  
*06: washbasin 80, glossy white furniture*





**ERIKA pro Q**

07: VASO + BIDET SOSPESI

08: VASO + BIDET FILO MURO

09: VASO MONOBLOCCO FILO MURO CON CASSETTA

10: VASO FILO MURO + MONOLITH

*07: wall hung wc + bidet*

*08: back to wall wc + bidet*

*09: back to wall coupled wc with cistern*

*10: back to wall wc + MONOLITH*





12



13



14

**ERIKA pro**

- 11: VASO + BIDET SOSPESI
- 12: LAVABI 62 CON SEMICOLONNA
- 13: VASO MONOBLOCCO CON CASSETTA
- 14: VASO + BIDET

- 11: wall hung wc + bidet*
- 12: washbasins 62 with siphon cover*
- 13: coupled wc with cistern*
- 14: wc + bidet*





**FORME IDEALI  
PER SPAZI CONTENUTI**

---

IDEAL SHAPES  
FOR SMALL SPACES

**YOU & ME**



01: LAVABO 46 SINISTRO  
02: VASO D'ANGOLO DESTRO

*01: washbasin 46 left  
02: right-hand corner wc*





03: LAVABO 46 SINISTRO, VASO D'ANGOLO DESTRO

*03: washbasin 46 left, right-hand corner wc*





- 04: LAVABO 90  
05: LAVABO 92 DOPPIO  
06: LAVABO 70
- 
- 04: *washbasin 90*  
05: *twin washbasin 92*  
06: *washbasin 70*



A photograph of a shower tray with a drain cover and a soap dish. The shower tray is white and has a dark, perforated drain cover in the center. A small, round, gold-colored soap dish is placed on the tray. The background is dark and out of focus.

**LA NUOVA GENERAZIONE  
DI PIATTI DOCCIA**

---

THE NEW GENERATION  
OF SHOWER TRAYS

**LIF** showertrays



01



**LIF.ST showertrays CERAMIC**

01: LIF.ST 100x80







**LIF.ST showertrays CERAMIC**

02: LIF.ST 120x70

03: LIF.ST 90x90



04



05



06

**LIF.RO showertrays CERAMIC**

04: LIF.RO 120x70

05: LIF.RO 90x90

06: LIF.RO 100x80



07



08

**LIF.RO showertrays CERAMIC**

07-08: LIF.RO 120x80





**LIF.ST showertrays HEAVYCRIL**

09: LIF.ST 160x80

10: LIF.ST 150x80

11: LIF.ST 140x80



**COMPORRE IN  
PIENA LIBERTÀ**

---

FREEDOM TO CREATE  
YOUR BATHROOM

**SLIDING** wood system



01





**WENGÈ**

01: PENSILE 140, PENSILE A GIORNO DESTRO 140

---

*01: unit 140, right open unit 140*



**WENGÈ**

02: COLONNE A GIORNO 140

03: PENSILE A GIORNO DETSRO 140, FUSION SOSPELI

04: BASE 100, LAVABI G-75, PENSILI 140

*02: tall open units 140*

*03: right open unit 140, wall hung FUSION*

*04: side unit 100, washbasins G-75, units 140*



05



06



07

**NOCE / NUT**

05: SPECCHIO, BASE 100, COLONNA 140, LAVABO G-100

06: BASE 100, LAVABO G-130

07: BASE LAVABO 100, NIDO 75

05: *mirror, side unit 100, tall unit 140, washbasin G-100*

06: *side unit 100, washbasin G-130*

07: *sink base unit 100, NIDO 75*



08



09



10

### WENGÈ

08: BASE LAVABO 120 + HAPPY HOUR 10:00

09: BASE LAVABO 100 + HAPPY HOUR 03:00

10: BASE LAVABO 100 + HAPPY HOUR 07:00

*08: sink base unit 120 + HAPPY HOUR 10:00*

*09: sink base unit 100 + HAPPY HOUR 03:00*

*10: sink base unit 100 + HAPPY HOUR 07:00*



**NOCE / NUT**

11: BASE LAVABO 100 + HAPPY HOUR 02:00

**WENGÈ**

12: BASE LAVABO 120 + HAPPY HOUR 11:00

13: BASE LAVABO 100 + HAPPY HOUR 17:00

14: BASE LAVABO 100 + HAPPY HOUR 22:00

*11: sink base unit 100 + HAPPY HOUR 02:00*

*12: sink base unit 120 + HAPPY HOUR 11:00*

*13: sink base unit 100 + HAPPY HOUR 17:00*

*14: sink base unit 100 + HAPPY HOUR 22:00*

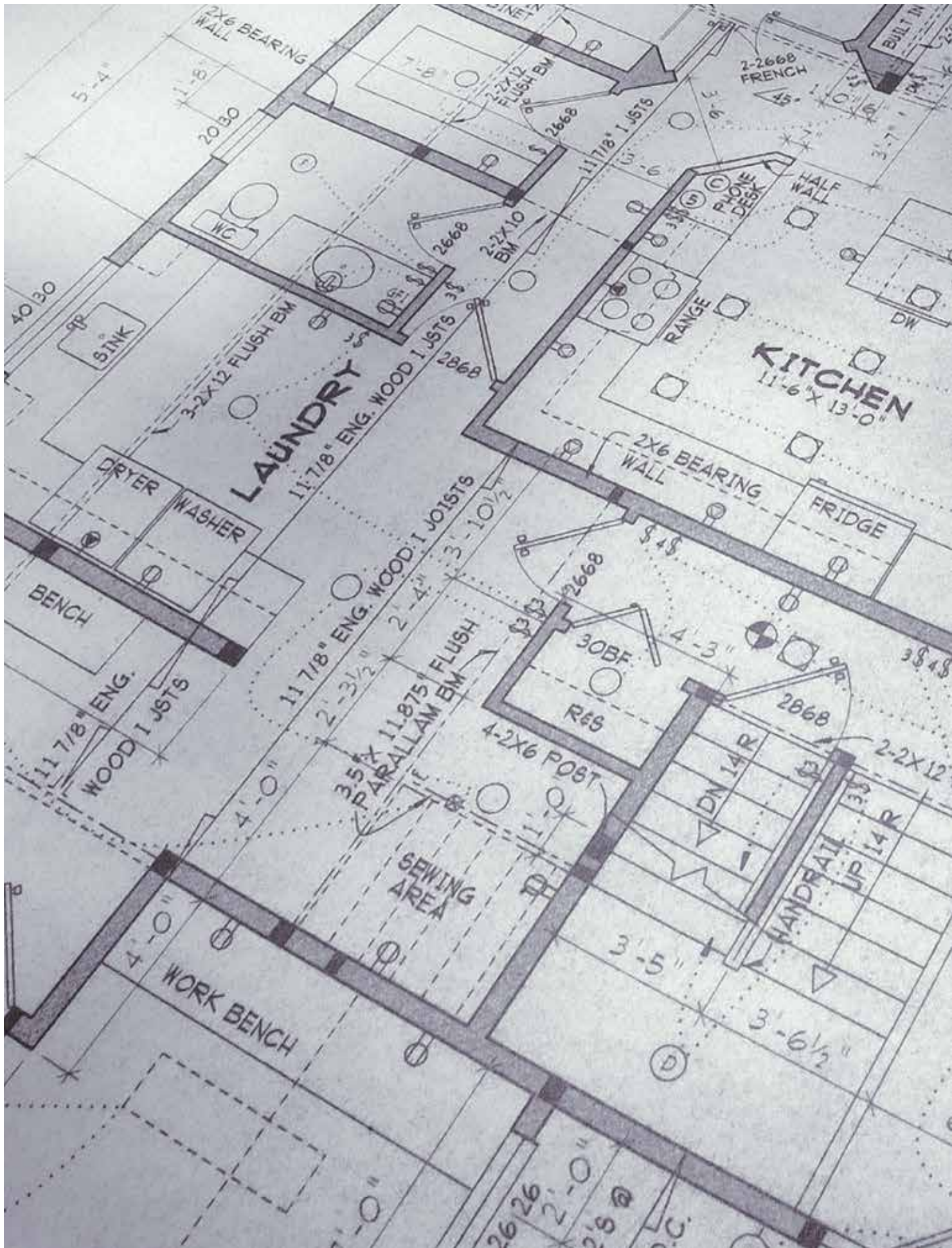



**SOLUZIONI MODULARI E FLESSIBILI  
PER IL MONDO PROFESSIONALE**

MODULAR AND FLEXIBLE SOLUTION  
FOR THE PROFESSIONAL WORLD

pro come  
**PROGETTO**







## LAVABI SOSPESI O DA MOBILE

Suspended or cabinet washbasins Hänge- oder Möbelwaschbecken Lavabos suspendus ou sur meuble  
 Lavabos suspendidos o de mueble Раковины подвесные или встраиваемые в мебель

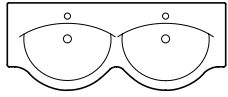

1250x500  
SOPHIE

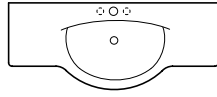

1200x500  
SOPHIE

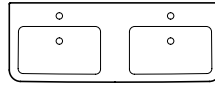

1200x450  
ERIKA pro

1250 / 1200

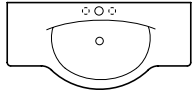

1050x500  
SOPHIE



1000x450  
ERIKA pro

1100 / 1000

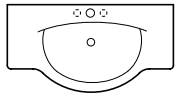

950x500  
SOPHIE

950

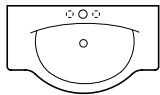

860x500  
SOPHIE

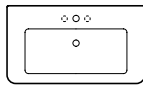

800x450  
ERIKA pro

860

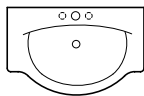

750x495  
SOPHIE

750

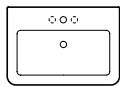

650x450  
ERIKA pro

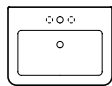

600x450  
ERIKA pro

650 / 600

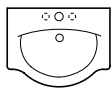

560x450  
SOPHIE

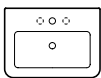

550x400  
ERIKA pro

550



450x380  
ERIKA pro

450

## LAVABI SOSPESI CON COLONNA O SEMICOLONNA

Wall-hung washbasins with full column or siphon cover Hängewaschbecken mit Standsäule oder Halbsäule Lavabos suspendus avec colonne ou demi-colonne Lavabos suspendidos con pedestal o semipedestal Раковины подвесные с колонной или полуколонной

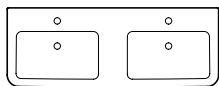

1200x450  
ERIKA pro

1200

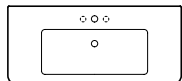

1000x450  
ERIKA pro

1000



800x450  
ERIKA pro

800

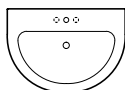

680x480  
ERIKA pro

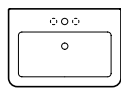

650x450  
ERIKA pro

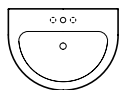

620x460  
ERIKA pro

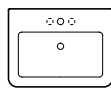

600x450  
ERIKA pro

680 / 650 / 600

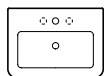

550x400  
ERIKA pro

550



450x380  
ERIKA pro

450

## LAVAMANI

hand-wash Handwaschbecken lave-mains lavamanos ракумойники



505x220  
DINO



450x380  
ERIKA pro



450x378  
DAYTIME

510 / 450

## SPECIALI

special basins Spezialprodukte accessoires spéciaux especiales комплектующие

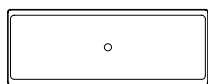

1200x450  
905x450  
LAVABI A CANALE

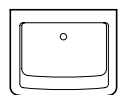

610x500  
LAVATOIO

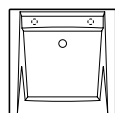

600x600  
SIXTY.LP  
600x500  
FIFTY.LP

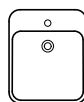

400x480  
LAVATOIO  
PILOZZO  
G-FULL



380x420  
LAVATOIO  
PILOZZO

## LAVABI INCASSO / INCASSO SOTTOPIANO / SEMINCASSO

Built in washbasins / undercounter / half built in Einbauwaschbecken / unterbauwaschtisch / halbeinbau Lavabos à vasque intégrée / sous plan / semi encastré  
Lavabos empotrados / bajo encimera / semiempotrados Раковины встраиваемые / встраиваемая под столешницу / полувстраиваемый

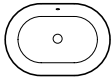

615x430  
DAYTIME  
(INCASSO)

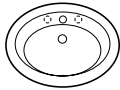

650x480  
DOLCEVITA  
(INCASSO)

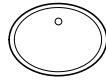

570x425  
CATERINE  
(INCASSO SOTTOPIANO)



500x380  
HAPPY HOUR 11:15  
(INCASSO SOTTOPIANO)



440x440  
HAPPY HOUR 07:15  
(INCASSO SOTTOPIANO)



480x480  
HAPPY HOUR 09:30  
(SEMINCASSO)

## PIATTI DOCCIA

Shower Trays Duschwannen Receveurs de douche Platos de ducha Душевые поддоны

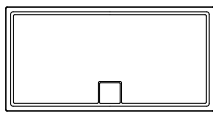

1600x800x45  
LIF.ST showertrays

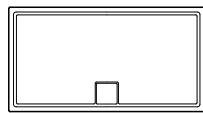

1500x800x45  
LIF.ST showertrays

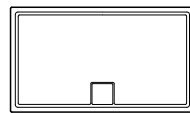

1400x800x45  
LIF.ST showertrays

1600 / 1500 / 1400

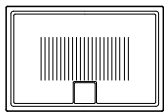

1200x800x60  
LIF.ST showertrays

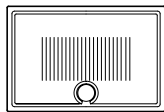

1200x800x60  
LIF.RO showertrays

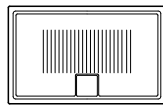

1200x700x60  
LIF.ST showertrays

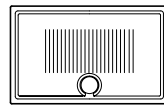

1200x700x60  
LIF.RO showertrays

1200

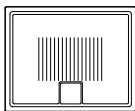

1000x800x60  
LIF.ST showertrays

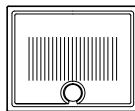

1000x800x60  
LIF.RO showertrays

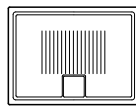

1000x700x60  
LIF.ST showertrays

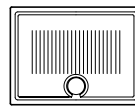

1000x700x60  
LIF.RO showertrays

1000

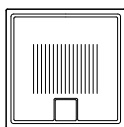

900x900x60  
LIF.ST showertrays

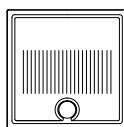

900x900x60  
LIF.RO showertrays

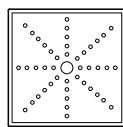

900x900  
AUTONOMY

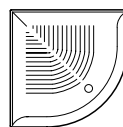

900x900x110  
DROP

900

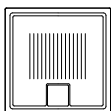

800x800x60  
LIF.ST showertrays

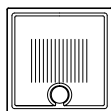

800x800x60  
LIF.RO showertrays

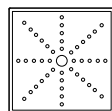

800x800  
AUTONOMY

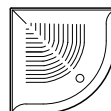

800x800x110  
DROP

800

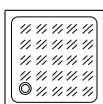

750x750x100  
PIATTO DOCCIA

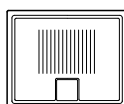

700x900x60  
LIF.ST showertrays

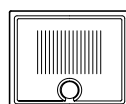

700x900x60  
LIF.RO showertrays

750 / 700

## VASI E BIDET SOSPESI

Wall-hung WCs and bidets Hängeklosetts und -bidets Cuvettes et bidets suspendus Inodoros y bidés suspendidos Унитазы и биде подвесные

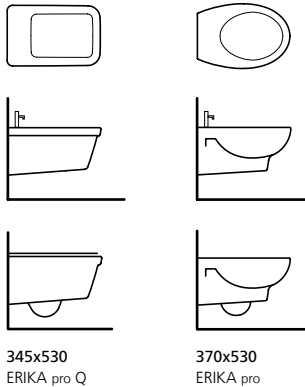

345x530  
ERIKA pro Q

370x530  
ERIKA pro

## VASI E BIDET A TERRA / VASI CON CASSETTA / MONOLITH

Floor-mounted WCs and bidets / WCs with cisterns / Monolith Standklosetts und -bidets / Klosetts mit Spülkasten / Monolith Cuvettes et bidets au sol / cuvettes avec chasse d'eau / monolith Inodoros y bidés de suelo / inodoros con cisterna / Monolith Напольные унитазы и биде / унитазы с бачком для слива / Monolith

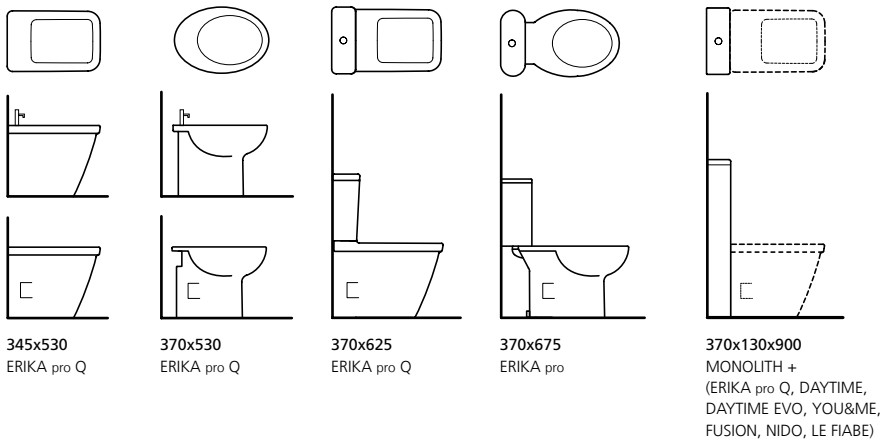

345x530  
ERIKA pro Q

370x530  
ERIKA pro Q

370x625  
ERIKA pro Q

370x675  
ERIKA pro

370x130x900  
MONOLITH +  
(ERIKA pro Q, DAYTIME,  
DAYTIME EVO, YOU&ME,  
FUSION, NIDO, LE FIABE)

## ORINATOIO

Urinal Urinale Urinoir Urinario Писсуары

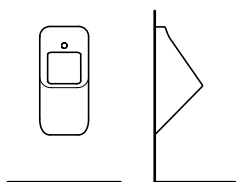

325x685  
ORINATOIO FUSION

## AUTONOMY

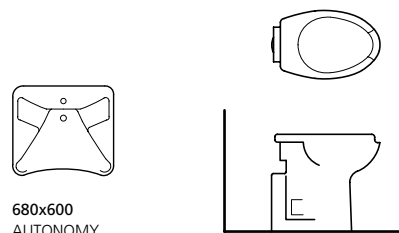

680x600  
AUTONOMY

380x595  
AUTONOMY

## BAGNO 1x1 m

Bathroom 1x1m Bad 1x1m Salle de bain 1x1 m Baño 1x1 m Ванная комната 1x1 м

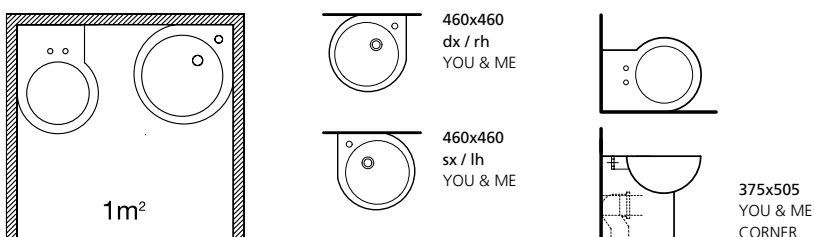

460x460  
dx / rh  
YOU & ME

460x460  
sx / lh  
YOU & ME

375x505  
YOU & ME  
CORNER



01

## LAVABI SOSPESI O DA MOBILE

01: LAVABO ERIKA PRO Q 80 SU MOBILE

*01: washbasin ERIKA pro Q 80 on furniture*



## LAVABI SOSPESI O DA MOBILE

02: LAVABO SOPHIE 95 SOSPESO  
03: LAVABO DOPPIO SOPHIE 125 SOSPESO

*02: wall hung washbasin SOPHIE 95  
03: wall hung double washbasin SOPHIE 125*



## LAVABI SOSPESI CON COLONNA O SEMICOLONNA

- 01: LAVABO SOSPESO ERIKA PRO Q 55 CON SEMICOLONNA  
02: LAVABO SOSPESO ERIKA PRO Q 60 CON COLONNA  
03: LAVABO SOSPESO ERIKA PRO Q 45

*01: wall hung washbasin ERIKA pro Q 55 with siphon cover  
02: wall hung washbasin ERIKA pro Q 60 with pedestal  
03: wall hung washbasin ERIKA pro Q 45*





01



02



03



04



05

## LAVABI INCASSO / SEMINCASSO / INCASSO SOTTOPIANO

- 01: LAVABO INCASSO DAYTIME  
02: LAVABO INCASSO SOTTOPIANO HAPPY HOUR 07:15  
03: LAVABO INCASSO SOTTOPIANO HAPPY HOUR 11:15  
04: LAVABO INCASSO SOTTOPIANO CATERINE  
05: LAVABO SEMINCASSO HAPPY HOUR 09:30

- 
- 01: built in washbasin DAYTIME  
02: built in undercounter washbasin HAPPY HOUR 07:15  
03: built in undercounter washbasin HAPPY HOUR 11:15  
04: undercounter washbasin CATERINE  
05: half built in washbasin HAPPY HOUR 09:30*



## LAVAMANI E SPECIALI

01: LAVAPANNI SIXTY.LP + MOBILE SIXTY.UNIT  
02: LAVAPANNI FIFTY.LP + MOBILE FIFTY.UNIT

*01: laundry sink SIXTY.LP + furniture SIXTY.UNIT  
02: laundry sink FIFTY.LP + furniture FIFTY.UNIT*



## PIATTI DOCCIA

- 01: LIFRO 80x80 CERAMIC
- 02: LIFST 100x80 CERAMIC
- 03: LIFST 160x80 HEAVYCRIL
- 04: DROP 80x80 CORNER



01

## **VASI E BIDET SOSPESI**

01: VASO E BIDET SOSPESI ERIKA PRO

*01: ERIKA pro wall hung wc and bidet*



01



02

## **VASI E BIDET A TERRA VASI CON CASSETTA**

01: VASO E BIDET ERIKA PRO  
02: VASO MONOBLOCCO CON CASSETTA ERIKA PRO

---

*01: wc and bidet ERIKA pro  
02: coupled wc with cistern ERIKA pro*



## CASSETTA MONOLITH

01: VASO D'ANGOLO DESTRO YOU & ME - 02: VASO YOU & ME  
 03: VASO FUSION 48 - 04: VASO ERIKA pro Q  
 CON CASSETTA MONOLITH

*01: corner wc right YOU & ME - 02: wc YOU & ME  
 03: wc FUSION 48 - 04: wc ERIKA pro Q  
 with MONOLITH cistern*



05



06



07



08

## CASSETTA MONOLITH

05: VASO FUSION - 06: VASO NIDO  
07: VASO DAYTIME - 08: VASO DAYTIME EVO  
CON CASSETTA MONOLITH

01: wc FUSION - 02: wc NIDO  
03: wc DAYTIME - 04: wc DAYTIME EVO  
with MONOLITH cistern



## AUTONOMY

- 01: LAVABO ERGONOMICO 68 + VASO APERTURA FRONTALE CON SEDILE  
 02: VASO APERTURA FRONTALE CON SEDILE SOLO ANELLO  
 03: VASO APERTURA FRONTALE CON SEDILE IN METACRILATO

*01: ergonomic washbasin 68 + front opening wc with seat cover  
 02: front opening wc with only front opening seat cover  
 03: front opening wc with acrylic seat cover*





### **BAGNO 1x1 m**

01: VASO D'ANGOLO DESTRO YOU & ME + LAVABO YOU & ME 46 ANGOLARE DX / SX

*01: corner wc right YOU & ME + corner wasbasin YOU & ME 46 right*



© Copyright Hatria Srl

Stampa Settembre 2015  
30000  
AAC

Hatria si riserva il diritto di apportare, in qualsiasi momento e senza preavviso, modifiche tecniche e dimensionali ai propri prodotti.  
Hatria reserves the right to change the models at any moment and without notice.



*hatria*

Via Tacito 5/B\_41123 Modena\_Italia  
tel. +39 0861 2011\_fax +39 059 7874210  
venditeitalia@hatria.com\_exportdpt@hatria.com\_marketing@hatria.com

[www.hatria.com](http://www.hatria.com)