

RAVAK[®]

Collection

COMPLETE OUTLINE OF RAVAK PRODUCTS 2015 / 2016



www.ravak.com



4	About Ravak		146	XXL
			148	Evolution
			150	You
			152	Magnolia
			154	Sonata
			156	Campanula II
			158	Chrome
			160	Classic
			162	Vanda II
			164	NewDay
			166	Gentiana
			168	LoveStory II
			170	10°
			172	Rosa II
			174	Rosa 95
			176	Rosa I
			178	Avocado
			180	BeHappy
			182	Asymmetric
			184	Drawings of Baths
			188	Bath Accessories
18	Ask the Frog			
		18		How to design your bathroom
		20		How to choose a shower enclosure
		22		Discover the possibilities of shower doors
24	RAVAK Concepts			
		26		10°
		28		Chrome
		30		BathGallery
		32		Evolution
		34		Rosa
		36		Classic
		38		Avocado
		39		BeHappy
40	Shower Enclosures and Shower Doors			
		42		Overview of shower enclosures
		46		Tailor-made Solutions
		48		Brilliant
		54		Walk-In
		58		SmartLine
		62		Matrix
		66		Chrome
		74		Rapier
		80		Pivot
		84		Blix
		90		Supernova
98	Seats and Hydro Massage Panels			
106	Shower Trays, Shower Channels and Floor Drains			
		108		Overview of Shower Trays
		110		Types of Shower Trays by Installation
		112		Galaxy Pro Chrome
		114		Galaxy Pro
		116		Galaxy Pro Flat
		118		Deep seating tray
		120		Galaxy
		122		Kaskada
		124		Shower Tray Accessories
		128		Shower Channels and Floor Drains
		132		Safe Bathroom
134	Baths			
		136		Overview of Baths
		140		Freedom R
		142		Freedom O
		144		BathGallery
		146		XXL
		148		Evolution
		150		You
		152		Magnolia
		154		Sonata
		156		Campanula II
		158		Chrome
		160		Classic
		162		Vanda II
		164		NewDay
		166		Gentiana
		168		LoveStory II
		170		10°
		172		Rosa II
		174		Rosa 95
		176		Rosa I
		178		Avocado
		180		BeHappy
		182		Asymmetric
		184		Drawings of Baths
		188		Bath Accessories
192	Bath Screens and Doors			
198	Wellness			
		200		RAVAK Hydro Massage Systems
204	Washbasins and Bathroom Furniture			
		206		BathGallery
		208		10°
		210		Chrome
		216		Evolution
		218		Rosa
		220		Classic
		222		Praktik
		224		Avocado
		225		BeHappy
		226		Washbasin Accessories
228	Chrome Concept for WC			
232	Water Taps and Extras			
		234		10°
		238		Chrome
		242		Freedom Tap
		244		Termo
		246		Neo
		248		Rosa
		250		Suzan
		252		Showers
		254		Accessories
		256		R-box
258	Cleaning Detergents			

Why RAVAK



BECAUSE YOU CAN TRUST OUR PRODUCTS

Established in 1991, RAVAK is still fully in the hands of the founding Czech owners. Starting with the production of shower enclosures and shower trays, the company has become the leader in the manufacture of bathroom products across Central and East Europe. Our success is based on adhering to the basic rules, such as supervision of uncompromising quality and original author's design, but what makes us truly different from the competitors is the fact that our products are in all respects customer oriented - they are comfortable, practical, reliable and beautiful at the same time.

We are trend creators, developing unique technical solutions, proprietary technologies and materials. Our aim is to offer complex equipment through our bathroom concepts in which the bath or shower are matched with a corresponding basin, furniture and a wide range of accessories in the same design.

Millions of satisfied customers across the world.



References

Capricorn Tower, Dubai



CLIENTS FROM ALL AROUND THE WORLD ENJOY THE BENEFITS OF RAVAK BATHROOM SOLUTIONS

Seventy percent of our total production is exported and we spread the good image of the European products to more than fifty countries around the world. You can find our bathroom equipment in the most famous hotels (Hotel President - Ukraine, Hotel Royal Azur - Tunisia, Hotel Orange - Spain, Pheonicia Grand Hotel - Romania, Marriott Hotel - Poland, Hotel Opera - Ukraine and many others).

The RAVAK products can also be found in many public spaces, recreational facilities, businesses, and mainly in homes.



*Hotel Konstantinovski
St. Petersburg, Russia*



*Skanes serail
Monastir, Tunisia*



*Marina MAG 218
Dubai, UAE*

STORZ *Design*

A DESIGNER IS NOT ONLY AN ARTIST OR NAIVE DREAMER

A good designer stands out for the great technical and engineering skills, be aware of practical context and provide the designed product with original form and technical imprint. Therefore, Ravak has chosen distinguished design studios, with creative ideas and well known stand in the most competitive environment, for example automotive industry.

The same designers who create bodies and interiors of top brand cars work also for RAVAK.



Achim Storz

- › top designer in the automotive and sports industries
- › designer for Lotus and McLaren
- › founder of the DESIGN STORZ studio
- › creator of the Whitewater shower enclosure, and Rosa II, Avocado, LoveStory II, You, Magnolia and XXL baths

— STORZ



Study for the 3rd millennium



LoveStory II Bath

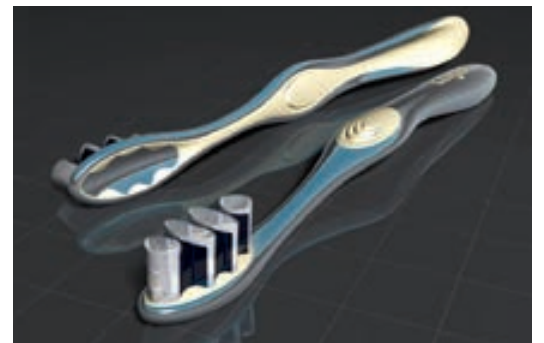

Design of the Colgate toothbrush

Design NOSAL

A SENSE OF HARMONY AND AESTHETIC THINKING ARE THE BASIS OF A GOOD DESIGN

However, the ability to give shape to beauty alone is not sufficient. As our technical world becomes increasingly complicated, each one of us needs to make some effort to find our way in it. Therefore we long not only for products of interesting design, but mainly for products that are practical, perfectly engineered, simple and safe.

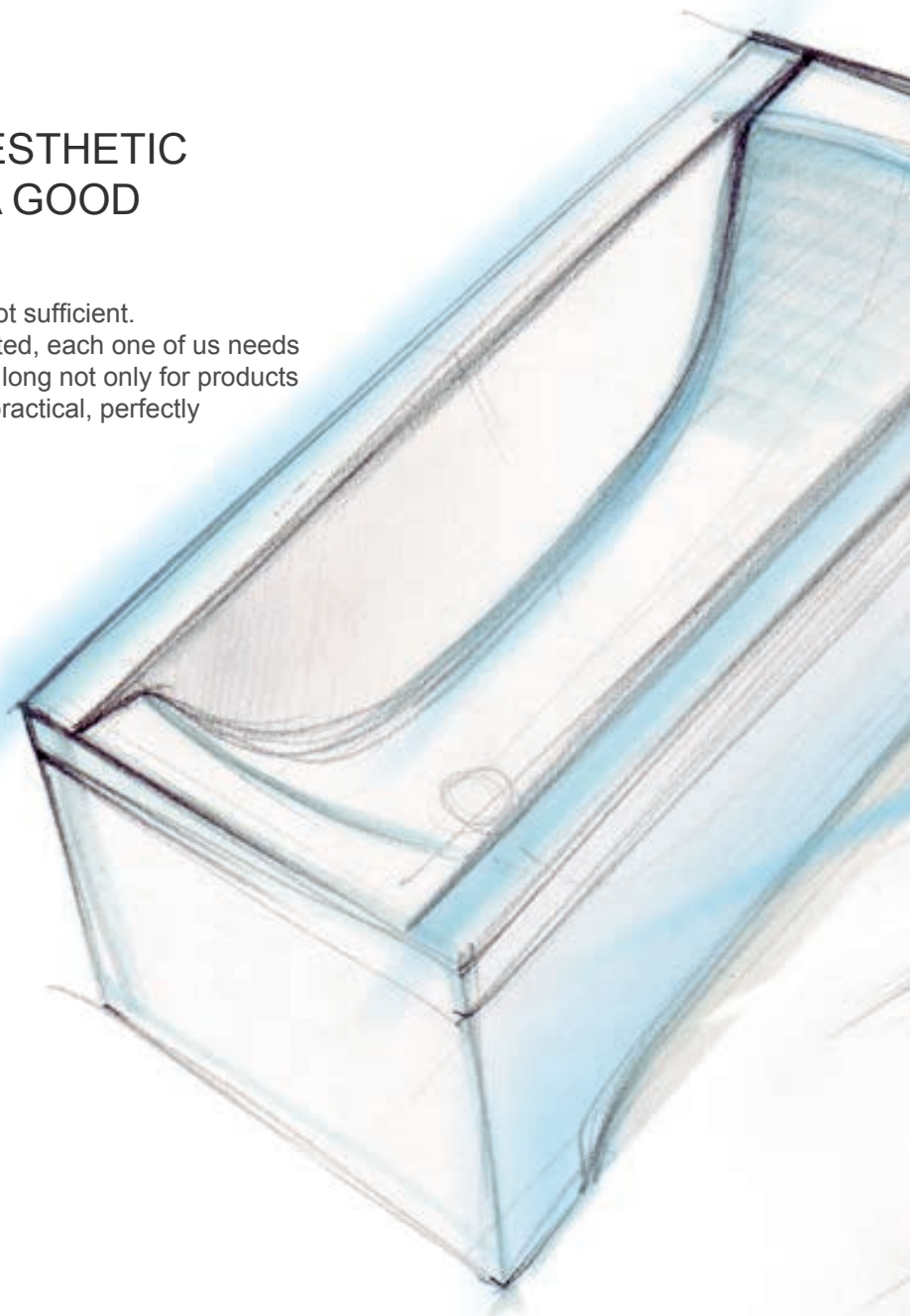

Kryštof Nosál

- › in 2013 nominated for the Czech Grand Design prize as a Designer of the Year for the BathGallery bath set
- › co-author of the OVO P shower seat and author of the Ovo B seat and Ovo B Decor
- › the author of basins made of cast materials and ceramics, bathroom concepts of 10°, Chrome, Evolution, BeHappy, Classic, Rosa 95, and the ranges of Pivot, SmartLine and Brilliant shower enclosures and shower doors
- › Co-author of the Washman - Electrolux washing machine designed specifically for men

design nosal[©]

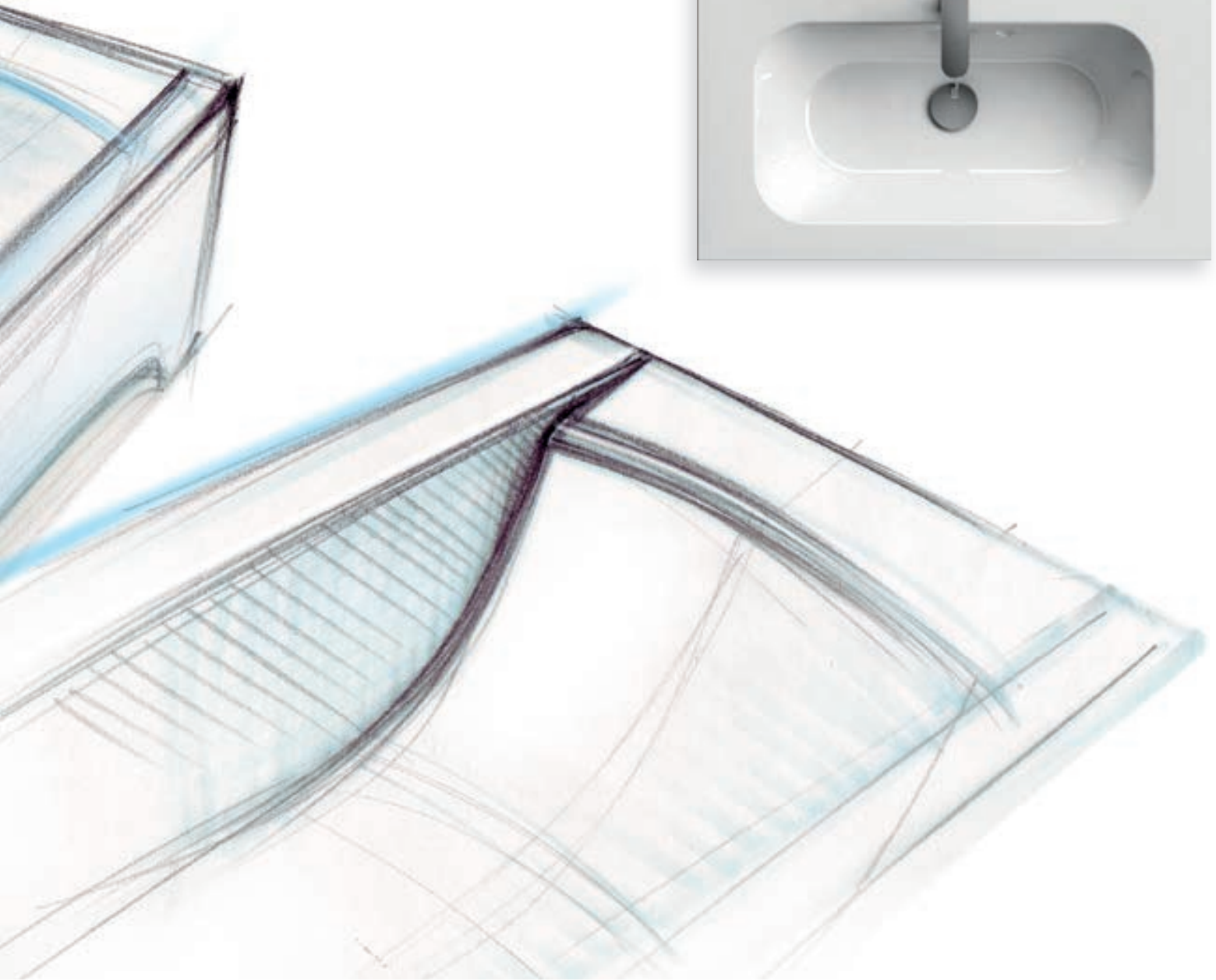

Screwdrivers for Narex



The Evolution bath was awarded in 2006 the Product of Excellence prize by the Design Centre Czech



Chrome Concept - equipment for the entire bathroom

RAVAK Technology



RAVAK Press Shop

Making an acrylic moulding of a future bath by using the advanced technology of vertical heating.

THE LATEST TECHNOLOGIES GIVE THE TOP QUALITY

Not only quality materials, but also the technology used, affects the final result. This is why in 2008 we opened a unique electroplating plant as the only manufacturer of shower enclosures in Central and East Europe. Having our own electroplating plant and paint shop, we can guarantee top quality finishing of our shower enclosures, doors and bath screens as their quality is constantly monitored.

On the same principle, in the bath manufacture we use a new technology of vertical spot heating of acrylic plates, resulting in a perfect extraction of the plate into the mould. To reinforce the bathtub by the PU Plus technology, we worked with Kawasaki to develop double coating technology using hard polyurethane foam, which makes these tubs sturdy, giving them unique thermal insulation properties.



RAVAK Electroplating Plant



Anodising aluminium profiles - manufacture of the sturdiest shower enclosure, door and bath screen frames.

RAVAK Paint Shop



Electrostatic powder painting of aluminium frames of shower enclosures, doors and bath screens.

RAVAK AntiCalc®

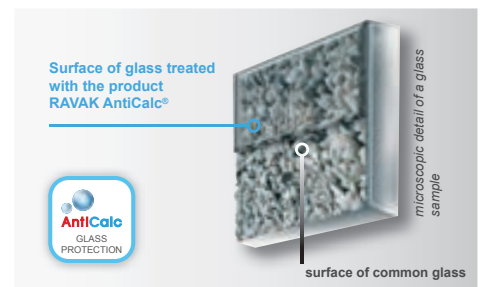

A revolutionary technology which creates an invisible protective layer over the surface of the glass, repelling water.

RAVAK Materials

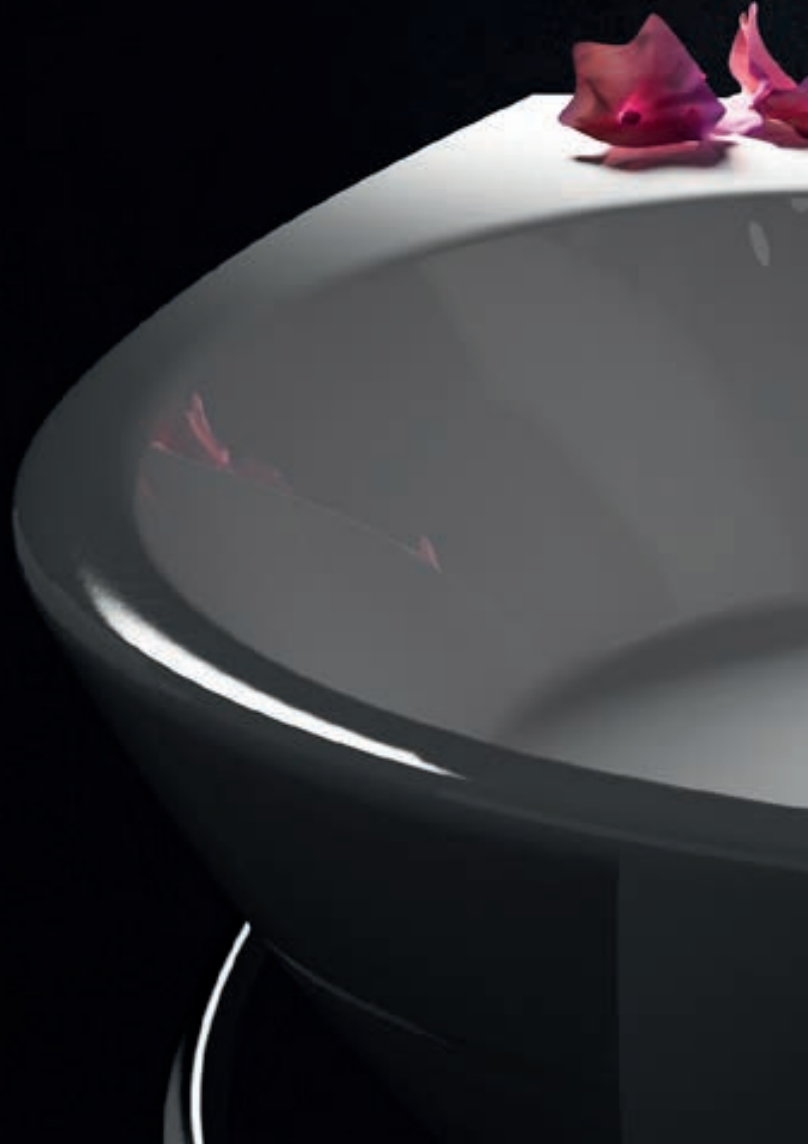

Cast Marble

It is a mixture of ground dolomite and resin used to produce washbasins and shower trays

IN THE AREA OF NEW MATERIAL DEVELOPMENT, WE WORK WITH TOP RESEARCH LABORATORIES IN EUROPE AND THE USA

We all know it, two things that look the same, have different durability. We pay great attention to material selection. For example, the quality of a bath depends on what type of acrylate it is made of. This is why we use the highest quality cast acrylic (PMMA) which retains its shape for a long time and there is no danger of cracks or distortion. The same attention is paid to the reinforcement of the baths; to achieve the highest quality in both ways of bath reinforcement we had to develop our own mixtures and technologies. The development of the PU Plus material was conducted in collaboration with the well-known German company Bayer. And even in apparant ordinary things, such as material for the manufacture of bathroom furniture, we leave nothing to chance and pay close attention to its selection and testing of moisture resistance.



Fibreglass



Highly effective reinforcement of acrylic products with polyester resin with glass fibre.

PU PLUS

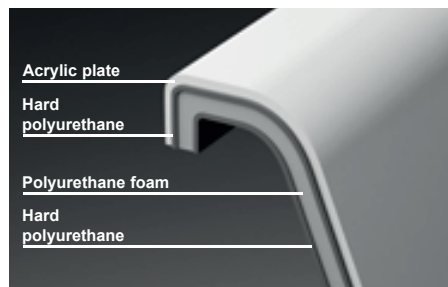

Exclusive technology of reinforcing acrylic baths with polyurethane foam. RAVAK's patent.

Chipboard



Bathroom furniture is manufactured from quality chipboard treated by high-quality moisture impregnation from leading European manufacturers.

RAVAK New Products 2015

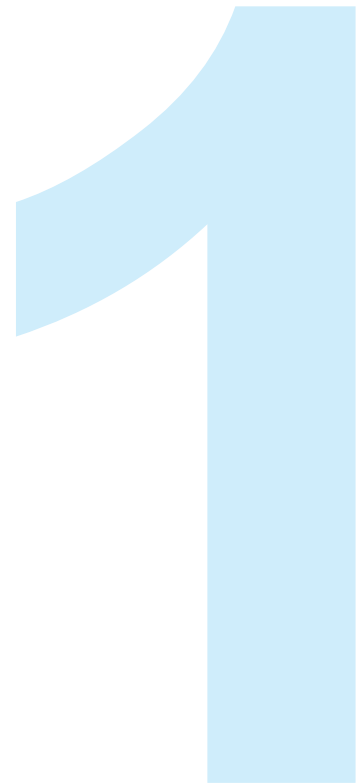

Bathroom concept 10° which is coming towards you.

The concept is based on a slight rotation or slant of the components at an angle of 10°. The bath, washbasins and water taps give the impression as if they were coming to meet you, adding more comfort and utility.

WE LISTEN TO OUR CUSTOMER NEEDS AND FOLLOW GLOBAL TRENDS AS WELL

Clever solution of the space is the alpha and omega of any bathroom. When this requirement is taken up by a creative product designer and the team of skilled craftsmen in RAVAK's manufacturing department, it results in unique collections such as our new concept 10°.

In everyday use you will appreciate its usability and fresh design which you will never find boring.

We bring a new range of the Matrix shower enclosures for shower fans, and to make the bathroom perfect we offer a new rectangular free-standing bath Freedom R or a set of anti-slip strips/squares for safe movement in the bathroom.

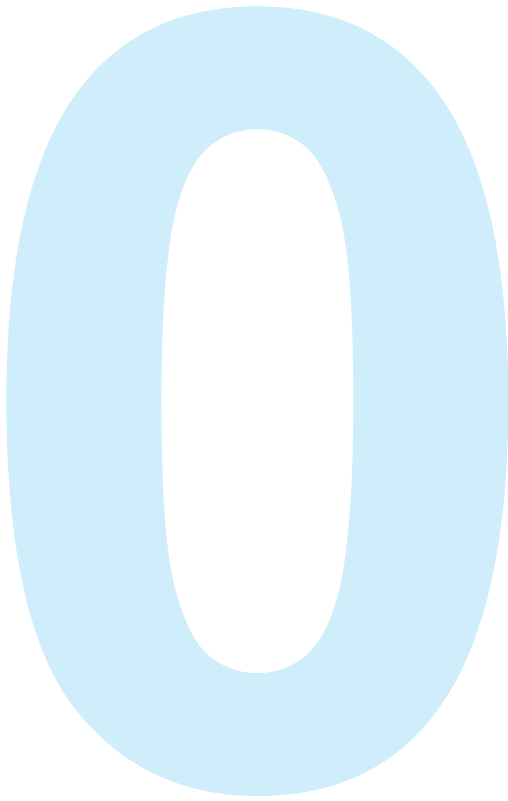

Matrix shower enclosures



Original shower enclosures with elegant construction and no lower guiding profile

Freedom R bath



A free-standing bath with a water tap which will give you absolute freedom.

Safe bathroom



The SafeStep anti-slip strips or squares for safe movement in the bathroom.

Ask the Frog *how to design your bathroom*



Development of functional and well planned bathrooms belongs to our everyday activities. We will be happy to assist you.



Before you start designing a bathroom ask yourself a few essential questions that will help you decide:

- 1 How many people are going to use the bathroom?**
You need to consider the available space, sufficient shelf and storage space and choice of furniture.
- 2 Do you want a bath, shower enclosure, or both?**
If you cannot fit both a bath and a shower into your bathroom, use the elegant combination of a bath with a screen.
- 3 Do you want a toilet included in your bathroom, or do you prefer two separate rooms?**
If there are more than two people sharing the household, separating the bathroom and wc will be a smart solution .
- 4 You don't have as much space available as you need?**
Enlarge the bathroom by taking a part of a neighbouring room.



A solution for both smaller and mid bathrooms with a shelf space on the bath, a bath screen and a high column cabinet - the Rosa Concept.



Both a bath and a shower enclosure in the bathroom.



A toilet divided by a partition from the rest of the bathroom.



Clever and space-saving solution for bathrooms - the Avocado Concept

How to Choose a Shower Enclosure?



What needs to be considered:

Shape



oval



square or rectangular

Construction

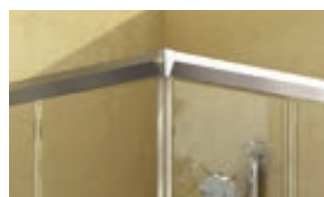

framed



frameless

Size



90x90 cm or 80x100 cm?

Sealing quality



framed corners



frameless corners



You should consider not only the look of your shower enclosure, but also what type of construction and size will suit you best, what type of opening you prefer for your bathroom, etc.



Type of opening (sliding, folding, turning / with pivot, or turning / hinged)

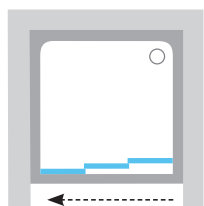

Sliding
doesn't take up space and water runs back into the tray.

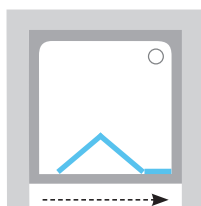

Folding and sliding
- large entrance which prevents water from running out of the shower enclosure.

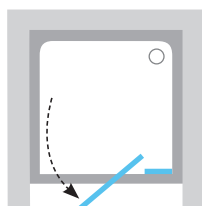

Turning / with pivot
- a simple system of maintenance-free door opening.

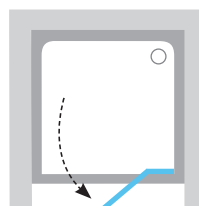

Turning / hinged
equipped with a rising mechanism that enables the door to lift and lock in the main position.

For more details on the Ask the Frog help, please visit www.ravak.com:



Discover the Possibilities of Shower Doors



Choose the right combination of shower door for your bathroom.

Do not let standard shower enclosure dimensions limit your decision and discover shower door options. You can save up to half of the shower enclosure price, while creating a larger space for showering. Consider the dimensions. You may prefer showering space 80 x 100 cm instead of 90 x 90 cm. It takes up the same area, but the utility is increased.

Possible solutions:

- 1 Shower door with a fixed wall
- 2 Shower door with a brick partition
- 3 Dividing the room with a shower door or enclosing a niche

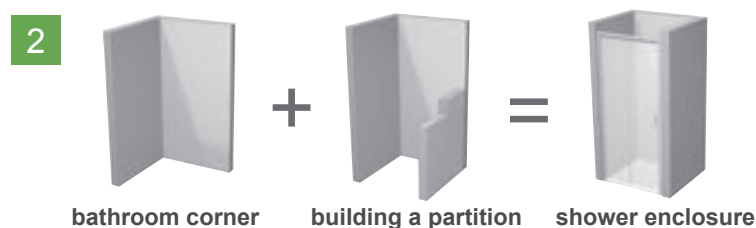
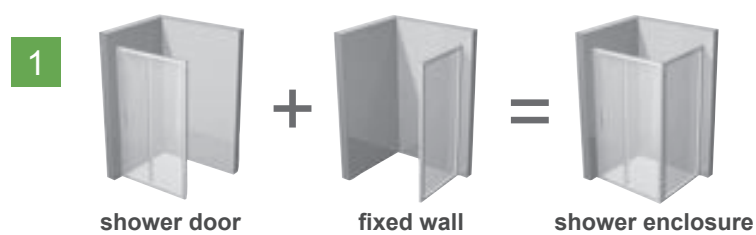



3



Dividing the room



Utilising a niche

For more details on the Ask the Frog help, please visit www.ravak.com:

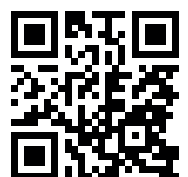

Concepts RAVAK

Design co-ordinated unit

The RAVAK bathroom concepts provide you with confidence when furnishing a bathroom. Clear idea, unified design, precise workmanship, these are the main benefits of the RAVAK concepts.

Each of the concepts is based on the design of the bath which can also be evident in the shower, basins, bathroom furniture, bath screen, water taps and practical accessories.

RAVAK concepts are suitable for bathrooms of all sizes, from the smallest to the premium ones.

2

1





1

Baths and Accessories

2

Bath Screens and Bath Doors

3

Washbasins and Bathroom Furniture

4

Water Taps and Bathroom accessories

Concept 10°

Coming towards you



***Its the simplest ideas which tend to be the best.
Slight rotation by 10° leded to a practical and effective bathroom concept***



Asymmetric bath with shelf space or a seat, see p. 170



Bath screen, see p. 197



Slightly rotated washbasins offer more comfortable access, see p. 208

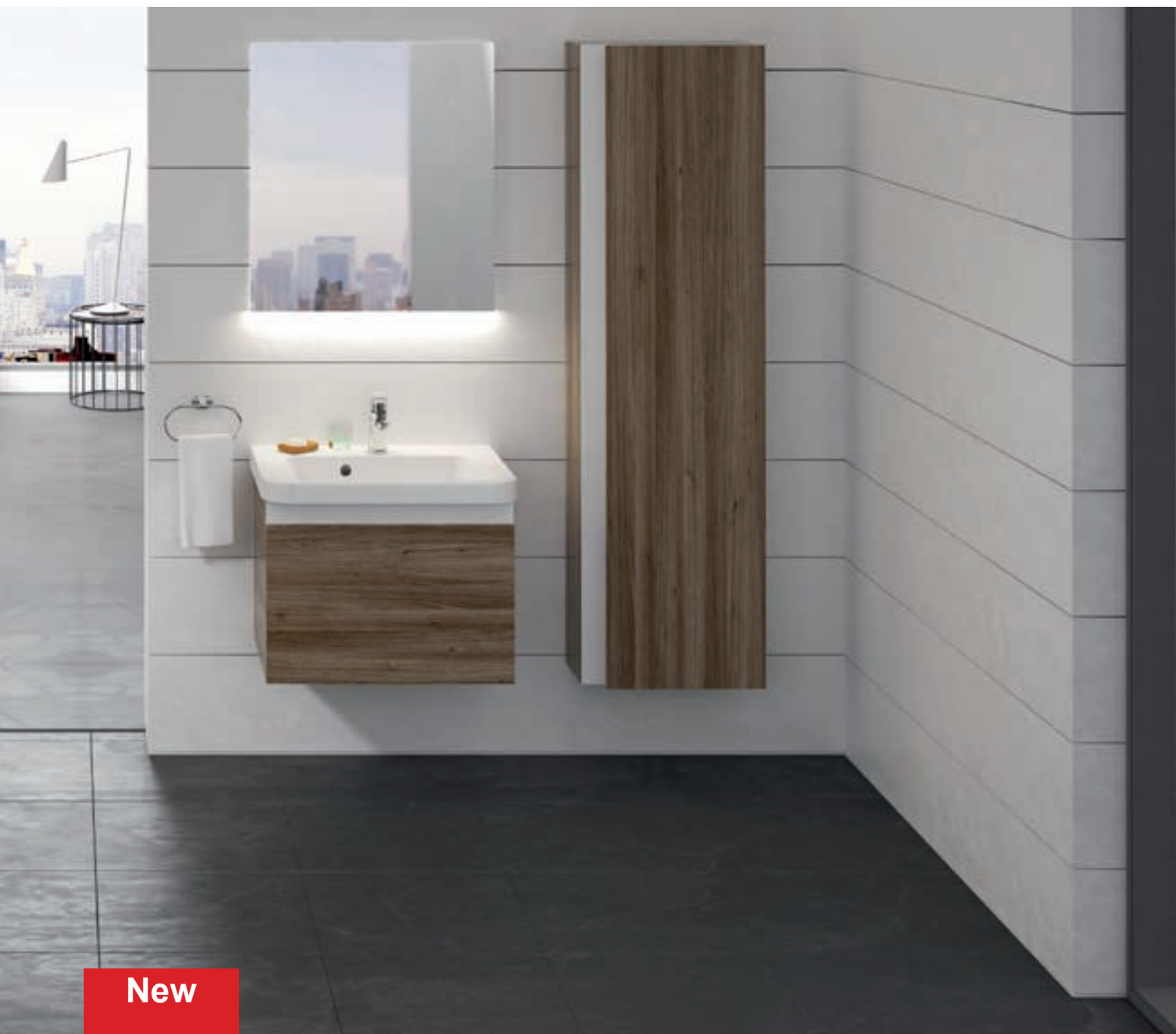

design nosal®



Bathroom Furniture,
see p. 209



High column cabinet with shelves,
see p. 209



Water taps see p. 234

Chrome Concept

The widest unified design concept on the market



Only perfect elements can create a perfect unit.



Baths with practical flat bottoms, see p. 158



Bath screen, see p. 194



Shower enclosures in various designs, see p. 66



Shower trays or channels, see p. 112 or 130

Chrome Concept



design nosal®



Seats,
see p. 100



WC, bidet
and accessories,
see p. 228



Washbasins, double washbasin,
small washbasin and bathroom
furniture, see p. 210



Water taps,
see p. 238



Bathroom accessories,
see p. 240



BathGallery Concept

Brings order to clutter

New

The basin, bath and accessories create a minimalist harmony in which every object has its place and together they always create a highly aesthetic and luxurious composition.



A bath with large storage area
and a raised edge
see p. 144

BathGallery Concept



design nosal®



Washbasins with colour replaceable bottoms, see p. 206



Bathroom Extras in five colours see p. 207



Evolution Concept

A harmonious set for an exceptional bathroom

***An unique design of rounded shapes that will enhance your bathroom.
A striking bath complemented by a washbasin and bathroom furniture in matching design.***



An exceptional bath,
see p. 148



Bath accessories,
see p. 148



design nosal®



Washbasin,
see p. 216



Bathroom furniture
in white colour,
see p. 217



High column cabinets
with shelves,
see p. 217



Mirror with a shelf,
see p. 217

Rosa Concept

A spacious shower enclosure together with a large bath



***Concept suitable for smaller as well as larger, luxury bathrooms.
Comprehensive and timeless solution, perfect in all details***



Surprisingly comfortable baths,
see p. 172 - 176



Bath Screens
see p. 197



Bath accessories,
see p. 172 - 176



design nosal®



Washbasins in different sizes
see p. 218



Bathroom furniture available
in three finishes
see p. 219



Rosa water taps
see p. 248

The Classic Concept

Simplicity is Beauty



A comprehensive bathroom solution where practicality and classic lines are the No. 1 emphasis.



Baths with a wide and flat bottom.
now with a length of 120 cm
see p. 160



Bath screens and doors
see p. 192



Bath accessories,
see p. 160



design nosal®



Washbasins, double washbasin and small washbasin in different sizes
see p. 220



Bathroom furniture available in four colours featuring special finish against humidity and high-quality fittings
see p. 221



High column cabinets with shelves,
see p. 221

Avocado Concept



The Concept comprises a small yet comfortable bath and a practical washbasin. Perfectly suited into the tiniest bathrooms.

STORZ



The most space-saving bath
see p. 178



Washbasins with ample shelf space
suitable for fitting above a bath
see p. 224



*The most space-saving bathroom solution
for comfortable bathing and showering.*

design nosal®



Bathtub that saves water and space
see p. 180



Bath screen that can be folded
flat against the wall
see p. 195



Washbasin designed
to be hung above the bath,
see p. 225





Shower enclosures

A wide variety to choose from

A large quantity of models, but also the principles of opening, types of panels and door frames, more ways to solve the plan and floor of the shower enclosure. These are the main characteristics of the RAVAK shower enclosures.

But the unifying principle has always remained uncompromising quality, tightness and a guarantee of long life.

Wide selection

More than 500 types of shower enclosures available.
Choose from our nine model lines and build your dream bathroom.

Brilliant

page 48



Walk-In

page 54



Chrome

page 66



Rapier

page 74



SmartLine

page 58



Matrix

page 62



Pivot

page 80



Blix

page 84



Supernova

page 90



A Great Variety for Everyone...

Frame finish of shower enclosures and shower doors

White

varnished profiles
made of thick-walled
aluminium

For the Matrix, Chrome, Rapier,
Pivot, Blix, Supernova ranges

Satin

anodised profiles
made of thick-walled
aluminium

For the Matrix, Chrome, Rapier,
Pivot, Blix, and Supernova
ranges (only for some products)

Chrom

chromium-plated metal
hinges / brackets / handles

For the Brilliant and SmartLine
ranges

Gloss

polished, anodised profiles
made of thick-walled
aluminium

For the Matrix, Chrome, Pivot,
and Blix ranges

Panels of shower enclosures, shower doors and bath screens

Safety glass - treated with the AntiCalc® protective layer

Transparent

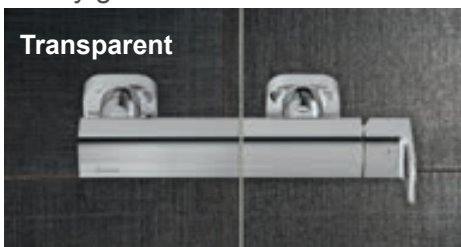

All shower enclosure ranges

Grape

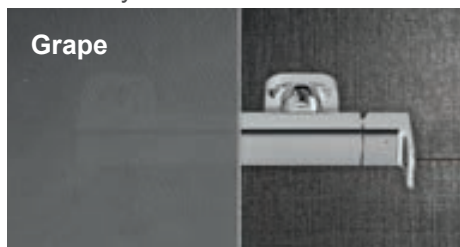

For the Rapier, Blix, and Supernova ranges

Graphite

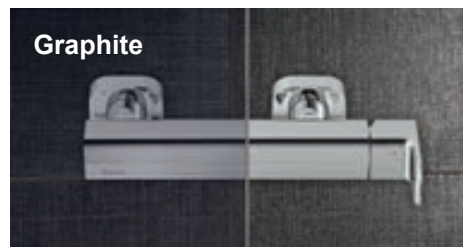

For the Blix range

Plastic

Pearl



Supernova

Rain



Supernova - only for bath screens

Handles for shower doors and enclosures

Brilliant



SmartLine



Matrix



Chrome



Rapier



Pivot



Blix



Fixing and Extension Profiles

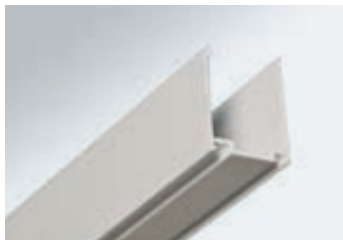

Fixing profile is used for mounting the shower enclosure or door onto the wall. **Not for independent sale, this profile is included as standard with every product as required.**



Extension profiles make it possible to extend the shower enclosure or door by 2 cm on each side. **Extension profiles are available for the following ranges. Pivot, Blix and Supernova**

Product (type)	Height (mm)	Colour		
		White	Satin	Gloss
PIVOT PNPS	1900	✓	✓	-
Blix BLNPS	1900	✓	✓	✓
Supernova NPS	1850	✓	✓	-
Supernova ANPS	1880	✓	✓	-

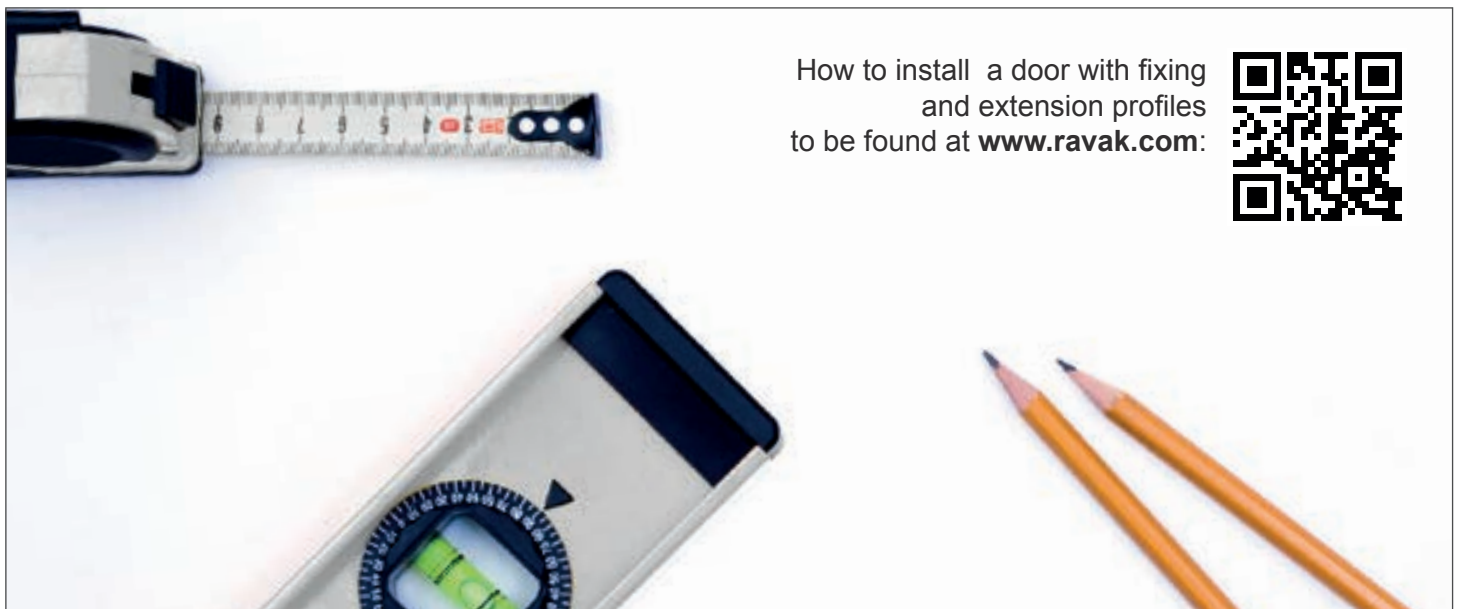

How to install a door with fixing and extension profiles to be found at www.ravak.com:

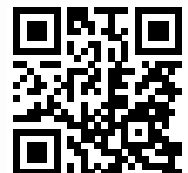

Tailor-made Solutions

Shower enclosure
into atypical space?
We have a solution!



*Do you have a an atypical bathroom?
You can't fit a shower enclosure
of standard dimensions in it?
We will customise it to your needs.*

*Try out the new configurator
of the RAVAK custom-built solutions.*

Our online configurator will help you create a product tailored to your bathroom (shower enclosure, shower door, fixed wall and bath screen/door). It lets you design your own product step by step, according to shape, size, type, frame/hinge colour, and panel. You can then comfortably send the defined product including the price calculation as an order and our staff will contact you promptly.

Configurator for your tailor-made solution will help you solve a non-standard height or width of the product. For further information go to www.ravak.com. However, if you need to solve angled ceilings, openings, non-standard vaults, easy-access entrances and such, feel free to contact us at atypy@ravak.cz, or call +420 318 427 288

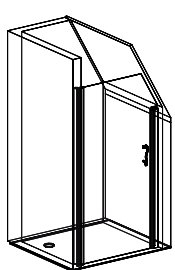

Non-standard shower door in an attic bathroom (slanted wall).

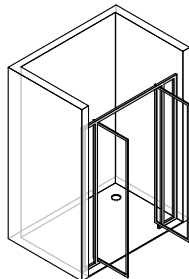

Widened shower door without a bottom frame (easy-access entry).



Outline of Solutions for Non-standard Situations

Product	Model	Min. height	Max. height	Min. width	Max. width	Min. depth	Max. depth	Angled ceilings and openings
BRILLIANT - also enables a wheelchair access								
Shower enclosures	BSKK4	x	only 1950	770	1400	770	1400	yes - but the fixed part only
	BSRV4	1000	2200	340	1400	340	1400	yes
	BSDPS			450	1400	450	1200	yes
Doors	BSD2	1000	2200	452	1450			yes
	BSD3			529	2350			yes
Bath screens	BVS2	1000	2200	452	1450			yes
	BVS1			100	1200			yes
WALK IN - enables a walk-in access only								
Shower enclosures	WALK-IN CORNER	1000	2500	800	1600			yes
	WALK-IN FREE	1000	2500	800	1600			yes
Fixed walls	WALK-IN WALL	1000	2500	800	1600			yes
Combination	WALK-IN COMBINATION	1000	2500	800	1600			yes
SMARTLINE - also enables a walk-in access solution								
Shower enclosures	SMSKK4	x	only 1900	785	1000	785	1000	yes - but the fixed part only
	SMSRV4	1000	2200	785	1000	785	1000	yes
Doors	SMSD2	1000	2200	890	1200			yes
Bath screens	SMPS	1000	2200	785	1200			yes
CHROME								
Shower enclosures	CRV1	1000	2050	700	1000			no
	CRV2	1000	2050	700	1600			no
	CRV1+CPS	1000	2050	700	1000			no
	CRV2+CPS	1000	2050	700	1600			no
Doors	CSD1	1000	2050	700	1000			no
	CSD2	1000	2050	900	1600			no
RAPIER								
Shower enclosures	NRKCP4	x	x	775	1400	775	1400	no
	NRKRP4	x	x	x	x	x	x	no
	NRKR2	1000	2200	630	1400	630	1400	no
	NRDP2 + RPS	1000	2050	780	1600	165	1200	NRDP2 - no, RPS - yes
	NRDP4 + RPS			787	2150	165	1200	NRDP4 - no, RPS - yes
Doors	NRDP2	1000	2050	780	1600			no
	NRDP4	1000	2200	787	2150			no
Fixed walls	RPS	1000	2050	165	1200			yes
PIVOT								
Shower enclosures	PSKK3	x	x	770	1400	770	1400	no
	PDOP1 + PPS	1000	2050	482	1000	100	1300	PDOP1 - no, PPS - yes
	PDOP2 + PPS			582	1600			PDOP2 - no, PPS - yes
Doors	PDOP1	1000	2050	482	1000			no
	PDOP2			582	1600			no
Fixed walls	PPS	1000	2050	100	1300			yes
Bath Screens	PVS1	1000	2050	100	1300			yes
BLIX								
Shower enclosures	BLCP4	x	x	x	x	x	x	no
	BLRV2K	1000	2050	630	1500	630	1500	no
	BLDP2 + BLPS			630	1600	165	1200	BLDP2 - no, BLPS - yes
Doors	BLDP2	1000	2050	630	1600			no
Fixed walls	BLPS	1000	2050	165	1200			yes
SUPERNOVA - also enables a wheelchair access								
Shower enclosures	SKKP6			750	1400	750	1400	no
	SKCP4							no
	SRV2-S			640		640		yes - but the fixed part only
	ASRV3			500	1300	500	1300	yes - but the fixed part only
	ASDP3 + APSS	1000	2050	648	2080		1050 (APSS plastic) 1300 (APSS glass) 2100 (APSS divided)	ASDP3 - yes - but the fixed part only APSS - yes
	SDOP + PSS			463	2050	165		yes
	SDZ2 + PSS				750			SDZ2-no, PSS=yes
	SDZ3 + PSS			512	1600		1050 (PSS plastic) 1300 (PSS glass) 2100 (PSS divided)	SDZ3 - yes - but the fixed part only PSS - yes
	Doors	ASDP3			648	2080		
SDOP		1000	2050	463	2050			yes
SDZ2				512	750			no
SDZ3				512	1600			yes - but the fixed part only
Fixed walls	APSS							yes
	PSS	1000	2050	165	1050 (plastic) 1300 (glass)			yes
	DSS							yes
Bath Screens	VS2			145	1045			yes - but one part only
	VS3			200	1500			yes - but one part only
	VS5	1000	2050	305				yes - but one part only
	VSK2			x	x			yes - but one part only
	AVDP3			648	2050			yes - but the fixed part only
	VDKP4			x	x			yes - but the fixed part only

Note: When combining a door with a fixed wall, the min./max. width applies for the shower door and min./max. depth for the fixed wall!



Brilliant
Honed perfection

Brilliant



New ergonomic handle - pure metal and solid design highlight the stately impression of the entire shower enclosure.



Sleek metal fittings - square, flat shape of metal elements distinguishes the Brilliant shower enclosure from all other enclosures on the market. Hinges are recessed into glass inside the shower enclosure, which simplifies maintenance in a revolutionary way.



Enables to **lift the door** and lock it in the main position



Glass is protected using the RAVAK AntiCalc® surface treatment technology



High-quality chromium-plated fittings have a minimum lifespan of 30 years.

Quadrant Shower Enclosures



BSKK3 - three-part quadrant shower enclosure

A luxurious product which will be a centrepiece of every bathroom.

Recommended shower trays: Elipso, Elipso Pro, Elipso Pro Flat, Elipso Pro Chrome or a shower channel or drain

Finish

CHROME

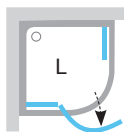

Complement your new shower enclosure by the RAVAK thermostatic tap which will keep constant temperature of water.

► See p. 244

Product (type)	Entrance (mm)	Dimensions (mm)	Price (pc)	Price (set)
■ BSKK3 - 80 L/R	763	783-795x783-795	✓	✓
■ B SET - 80			✓	✓
■ BSKK3 - 90 L/R	763	883-895x883-895	✓	✓
■ B SET - 90			✓	✓
■ BSKK3 - 100 L/R	905	983-995x983-995	✓	✓ ●
■ B SET - 100			✓	✓ ●

■ Height of the product is 1950 mm. ● One short holder included.
The products are usually delivered within 14 days.



BSKK4 - four-part quadrant shower enclosure

Luxurious and user-friendly. While maintaining all style requirements, it offers a comfortable entrance, and the door takes up less space in the bathroom when opened.

Recommended shower trays: Elipso, Elipso Pro, Elipso Pro Flat, Elipso Pro Chrome or a shower channel or drain

Finish

CHROME

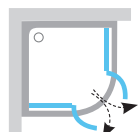

The B SET includes hinges, brackets, handle, mounting kit and, in selected sets, also the Brilliant holders.

Product (type)	Entrance (mm)	Dimensions (mm)	Price (pc)	Price (set)
■ BSKK4 - 80	761	783-795x783-795	✓	✓
■ B SET - 80			✓	✓
■ BSKK4 - 90	761	883-895x883-895	✓	✓
■ B SET - 90			✓	✓
■ BSKK4 - 100	761	983-995x983-995	✓	✓ ●
■ B SET - 100			✓	✓ ●

■ Height of the product is 1950 mm. ● Set of 2 short holders included.
The products are usually delivered within 14 days.



BSRV4 - four-part shower enclosure - corner entry

With extra wide entry among corner shower enclosures - entry up to 90 cm wide.

Recommended shower trays: Perseus, Perseus Pro, Perseus Pro Flat, Perseus Pro Chrome or a shower channel or drain

Finish

CHROME

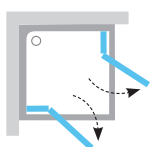

Maximum stability of the product is ensured by short and long holders of the glass panels, which can also be purchased separately for shower enclosures of smaller sizes.

Product (type)	Entrance (mm)	Dimensions (mm)	Price (piece)	Price (set)
■ BSRV4 - 80 B SET- 80	763	783-795x783-795	✓	✓
■ BSRV4 - 90 B SET- 90	763	883-895x883-895	✓	✓
■ BSRV4 - 100 B SET- 100	905	983-995x983-995	✓	✓ ●

■ Height of the product is 1950 mm. ● Set of 2 short holders included.
The products are usually delivered within 14 days.



BSDPS - shower door and fixed wall - front entry

The largest shower enclosure of the Brilliant range in a wide choice of sizes. Its dimensions of 90 x 120 cm make the enclosure ideal for two.

Recommended shower trays: Perseus, Perseus Pro, Perseus Pro Flat, Perseus Pro Chrome, Gigant Pro, Gigant Pro Flat, Gigant Pro Chrome or a shower channel or drain

Finish

CHROME

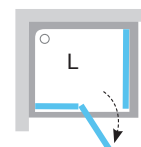

Product (type)	Entrance (mm)	Dimensions (mm)	Price (piece)	Price (set)
■ BSDPS - 80 L/R B SET- 80	527	783-795x783-795	✓	✓ ○
■ BSDPS - 90 L/R B SET- 90	527	883-895x883-895	✓	✓ ○
■ BSDPS - 100 L/R B SET- 100	627	983-995x983-995	✓	✓ ●
■ BSDPS - 100x80 L/R B SET- 100	627	983-995x783-795	✓	✓ ●
■ BSDPS - 110x80 L/R B SET- 110	627	1083-1095x783-795	✓	✓ ●
■ BSDPS - 120x80 L/R B SET- 120	627	1183-1195x783-795	✓	✓ ●
■ BSDPS - 120x90 L/R B SET- 120	627	1183-1195x883-895	✓	✓ ●

○ One long holder included ● One long and one short holder included
● Set of 2 long holders included.
■ Height of the product is 1950 mm. L - left hand product option. R - right hand product option.
The products are usually delivered within 14 days.

Shower Doors



BSD2 - two-part shower door

An ideal solution for niches. The shower door is ideal for showering space created out of a bricked niche with a width of 80 - 100 cm. It can be adjusted to building imperfections ranging from - 10 to + 5 mm.

Recommended shower trays: Perseus, Perseus Pro, Perseus Pro Flat, Perseus Pro Chrome, Gigant Pro, Gigant Pro Flat, Gigant Pro Chrome or a shower channel or drain

Finish

CHROME

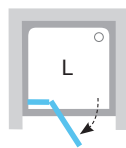
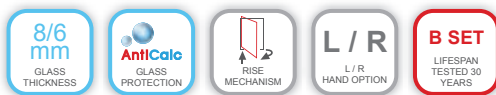

Choose either left or right hand door option. The option is determined by the location of the door hinges when looking from the outside.

Product (type)	Entrance (mm)	Dimensions (mm)	Price (piece)	Price (set)
■ BSD2 - 80 L/R	529	790-805	✓	✓
B SET - 80			✓	
■ BSD2 - 90 L/R	529	890-905	✓	✓
B SET - 90			✓	
■ BSD2 - 100 L/R	629	990-1005	✓	✓ ●
B SET - 100			✓	

■ Height of the product is 1950 mm. ● One short holder included.
L (left) - left hand product option. R - right hand product option.
The products are usually delivered within 14 days.

BSD3 - three-part shower door

Even wider. It can seal elegantly a bricked niche in a width up to 120 cm and is able to adapt to building imperfections ranging from - 15 to + 10 mm.

Recommended shower trays: Gigant Pro, Gigant Pro Flat, Gigant Pro Chrome or a shower channel or drain

Finish

CHROME

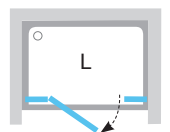

Maximum stability of the product is ensured by short and long holders of the glass panels, which can also be purchased separately for shower enclosures of smaller sizes.

Product (type)	Entrance (mm)	Dimensions (mm)	Price (piece)	Price (set)
■ BSD3 - 110 L/R	529	1085-1110	✓	✓
B SET - 110			✓	
■ BSD3 - 120 L/R	629	1185-1210	✓	✓ ●
B SET - 120			✓	

■ Height of the product is 1950 mm. ● One short holder included.
L (left) - left hand product option. R - right hand product option.
The products are usually delivered within 14 days.

Brilliant



Surround yourself with luxury



Walk-In

*Life doesn't have to be a compromise.
Customised shower enclosures.*

Walk-In

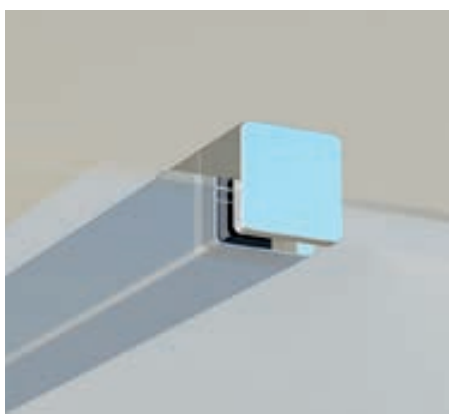

Metal bracket - The Walk-In shower solution includes one or two imperceptible metal brackets which safely hold the large glass panels in place providing stability to the entire enclosure.

Safe and nice looking- shower enclosures are made of safety glass with a thickness of 8 mm. Therefore they exhibit high strength. During the production, they are fitted with the AntiCalc protective layer preventing scale depositing on the glass which therefore does not require intensive daily maintenance.



Customised shower enclosures



Walk-In Wall - one fixed wall - with one side entrance

Nice-looking solution which will adapt to your requirements

We recommend: Install the product directly onto the floor with a built-in shower channel or drain.

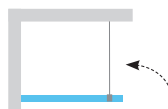

A design bracket is included with each Walk-In Free model.

Best selling dimensions - see the table

Product (type)	Entrance (mm)		
	800	900	1000
■ WALK-IN WALL 100	✓	✓	✓
■ WALK-IN WALL 110	✓	✓	✓
■ WALK-IN WALL 120	✓	✓	✓

■ Height of the product is 2000 mm.
1 bracket (80, 90 or 100) is included
Products are as standard delivered in 4 weeks.



Walk-In Corner - two fixed walls - one-side entry

A shower enclosure for free space.

We recommend: Install the product directly onto the floor with a built-in shower channel or drain.



You can complement your shower enclosure by a brass shower head of 30 cm in diameter.

▶ see p. 252

Best selling dimensions - see the table

Product (type)	Entrance (mm)	Dimensions (mm)	Price (piece)
■ Walk-In Corner	900	900x1200	✓

■ Height of the product is 2000 mm.
One bracket and one corner joint included with the product
Products are as standard delivered in 4 weeks.



Walk-In Free - one fixed wall with entrance from both sides

A spacious and airy option, which allows two people showering together.

We recommend: Install the product directly onto the floor with a built-in shower channel or drain.



Best selling dimensions - see the table

Product (type)	Entrance (mm)	Dimensions (mm)	Price (piece)
■ Walk-In Free	900	1600	✓

■ Height of the product is 2000 mm.
Set of 2 long holders included.



All these design options of the Walk-In products can be ordered through the online configurator of the custom-built solutions, or during a personal consultation when you select the required design (type, width, height). For more information go to www.ravak.com.

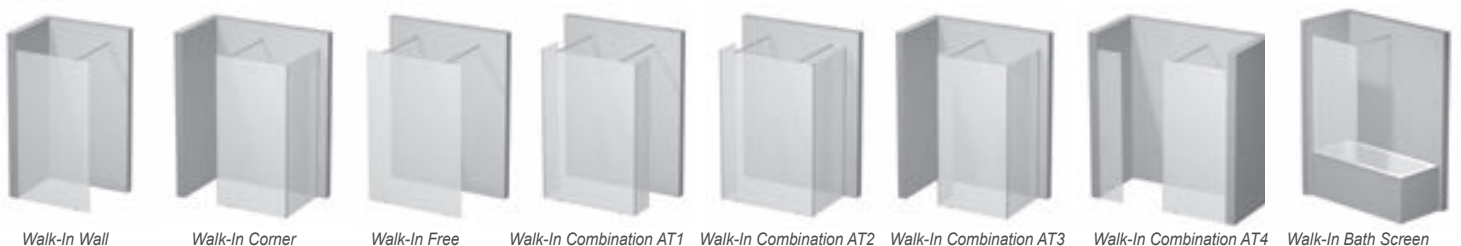

Products are as standard delivered in 4 weeks.



SmartLine

Shiny and Minimalist Bathroom Design



Fixing profile - enables easy and accurate mounting of the shower enclosure. It can compensate minor building imperfections. Final setting of the product can be adjusted by 15 mm.

SmartLine hinge - high-quality chrome-plated hinges reflect the latest bathroom design trends and add a clean and minimalist look to the SmartLine shower enclosures.



Enables to **lift the door** and lock it in the main position



Glass is protected using the RAVAK AntiCalc® surface treatment technology

Quadrant Shower Enclosure



SMSKK4 - four part quadrant shower enclosure

Balanced design shower enclosure. Large safety glass panels and high-quality chromium-plated fittings - these are the characteristic features of this elegant enclosure.

Recommended shower trays: Elipso, Elipso Pro, Elipso Pro Flat, Elipso Pro Chrome or a shower channel or drain

Finish

CHROME

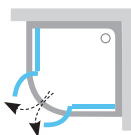

A bottom drip-ledge and an 18mm high one-part threshold strip ensure perfect sealing.

Product (type)	Entrance (mm)	Dimensions (mm)	Price (set)
■ SMSKK4 - 80	761	785-800x785-800	✓ ●
■ SMSKK4 - 90	761	885-900x885-900	✓ ●

- Height of the product is 1900 mm.
 - Set of 2 short holders included.
- The products are usually delivered within 14 days.

Note: New design of the SmartLine shower enclosures available from 04/2015.

Corner Shower Enclosures



SMSRV4 - four part corner entry shower enclosure

Features the greatest entrance width. In its entrance area, it provides the greatest comfort of all products from the SmartLine range.

Recommended shower trays: Perseus, Perseus Pro, Perseus Pro Flat, Perseus Pro Chrome or a shower channel or drain

Finish

CHROME

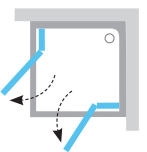

You can complement your shower enclosure by a brass shower head of 30 cm in diameter.

▶ see p. 252

Product (type)	Entrance (mm)	Dimensions (mm)	Price (set)
■ SMSRV4 - 80	763	785-800x785-800	✓ ●
■ SMSRV4 - 90	763	885-900x885-900	✓ ●

- Height of the product is 1900 mm.
 - Set of 2 short holders included.
- The products are usually delivered within 14 days.

Note: New design of the SmartLine shower enclosures available from 04/2015.

Shower Doors **SmartLine**



Complete product - combination of the SMSD2 + SMPS models.

SMSD2 + SMPS - shower door + fixed wall - front entry

A shower enclosure tailored to your needs. Combine the shower door with fixed wall to create a showering space in dimensions from 90 x 80 cm up to 120 x 100 cm.

Recommended shower trays: Perseus, Perseus Pro, Perseus Pro Flat, Perseus Pro Chrome, Gigant Pro, Gigant Pro Flat, Gigant Pro Chrome or a shower channel or drain

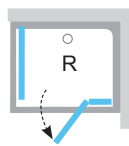
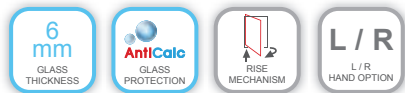

Finish
CHROME

Product (type)	Dimensions (mm)	Price (set)
■ SMPS - 80 L/R	785-800	✓ ●
■ SMPS - 90 L/R	885-900	✓ ●
■ SMPS - 100 L/R	985-1000	✓ ●

■ Height of the product is 1900 mm.

● One long holder included.

The products are usually delivered within 14 days.

Note: New design of the SmartLine shower enclosures available from 04/2015.



SMSD2 - two-part shower door

An ideal solution for niches. Install the shower door into a niche or create a new showering area by combining the door with the SMPS fixed wall.

Recommended shower trays: Perseus, Perseus Pro, Perseus Pro Flat, Perseus Pro Chrome, Gigant Pro, Gigant Pro Flat, Gigant Pro Chrome or a shower channel or drain

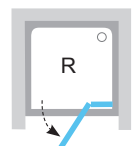

Finish
CHROME



Choose either left or right hand option. Left hand door requires left hand fixed wall and right hand door requires right hand fixed wall. For combination choose the B type door.

Product (type)	Entrance (mm)	Dimensions (mm)	Price (set)
■ SMSD2 - 90 L/R	629	A 889 - 906 / B 899 - 916	✓ ●
■ SMSD2 - 100 L/R	629	A 989 - 1006 / B 999 - 1016	✓ ●
■ SMSD2 - 110 L/R	629	A 1089 - 1106 / B 1099 - 1116	✓ ●
■ SMSD2 - 120 L/R	629	A 1189 - 1206 / B 1199 - 1216	✓ ●

Model **A** shower door is designed for a construction opening up to 11 mm smaller than the standard size of the product.

Model **B** is designed for a construction opening up to 16 mm larger than the standard size of the product. For example, if your already tiled niche for the shower door has the size 889 – 906 mm, buy model **A**, if it has the size 899 – 916 mm, buy model **B**.

■ Height of the product is 1900 mm.

● One short holder included.

The products are usually delivered within 14 days.

Note: New design of the SmartLine shower enclosures available from 04/2015.



Matrix

Style which speaks for itself

New



A design element for maximum stability
– A square shape plate characterizes the entire shower enclosure and fulfills also a practical function.

The lower threshold rail with a fixing guide – the fixing guide replaces the guiding profile. The Matrix enclosure looks so light and airy.



Minimum profiles and no unreachable spots



Glass is protected using the RAVAK AntiCalc® surface treatment technology

Corner Shower Enclosures



MSRV4 - four-part corner entry sliding shower enclosure

The most cost-effective shower enclosure of this range.

Recommended shower trays: Perseus Pro Chrome Frame finish or a shower channel or drain

GLOSS SATIN WHITE

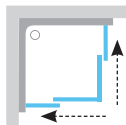

The shower enclosure can be complemented by a round or square shower head,

► see p. 252

Product (type)	Entrance (mm)	Dimensions (mm)	Safety glass panel		
			Transparent decor Frame finish		
			White	Satin	Gloss
■ MSRV4 - 80	430	785-805x785-805	✓	✓	✓
■ MSRV4 - 90	500	885-905x885-905	✓	✓	✓
■ MSRV4 - 100	570	985-1005x985-1005	✓	✓	✓

■ Height of the product is 1950 mm.
The products are usually delivered within 14 days.
Note: New design of the Matrix shower enclosures available from 1 July, 2015.



MSDPS - shower door and fixed wall - front entry

This modern corner-shaped shower enclosure offers more space for showering.

Recommended shower trays: Gigant Pro Chrome Frame finish or a shower channel or drain

GLOSS SATIN WHITE

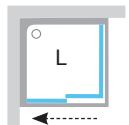

Use the SafeStep anti-slip strips or squares for safe movement in the bathroom.

► see p. 132

Product (type)	Entrance (mm)	Dimensions (mm)	Safety glass panel		
			Transparent decor Frame finish		
			White	Satin	Gloss
■ MSDPS - 100/80 L/R	429	985-1005x785-805	✓	✓	✓
■ MSDPS - 100/100 L/R	429	985-1005x985-1005	✓	✓	✓
■ MSDPS - 110/80 L/R	479	1085-1105x785-805	✓	✓	✓
■ MSDPS - 120/80 L/R	529	1185-1205x785-805	✓	✓	✓
■ MSDPS - 120/90 L/R	529	1185-1205x885-905	✓	✓	✓

■ Height of the product is 1950 mm.
The products are usually delivered within 14 days.
Note: New design of the Matrix shower enclosures available from 1 July, 2015.



MSD2 - two-part sliding shower door

The door can seal a showering space in a width up to 120 cm. Choose the left or right hand option. The door cannot be reversed additionally.

Recommended shower trays: Gigant Pro Chrome Frame finish or a shower channel or drain

GLOSS SATIN WHITE

8/6 mm
GLASS THICKNESS

AntiCalc
GLASS PROTECTION

L / R
L / R HAND OPTION



Product (type)	Entrance (mm)	Dimensions (mm)	Safety glass panel		
			Transparent decor		
			Frame finish		
			White	Satin	Gloss
MSD2 - 100 L/R	414	975-1015	✓	✓	✓
MSD2 - 110 L/R	464	1075-1115	✓	✓	✓
MSD2 - 120 L/R	514	1175-1215	✓	✓	✓



Jet Glass hydro-massage panel.

■ Height of the product is 1950 mm.

The products are usually delivered within 14 days.

Note: New design of the Matrix shower enclosures available from 1 July, 2015.



Chrome

With a Sense for Details



The harmonious oval shape blends into all elements, such as the handle, the rotary side post of the door, and the fixed wall bracket, combining them into a perfect aesthetic whole. The handle turned upwards is easy to operate and it can also be used as a towel hook.

Maximum stability of the product is ensured by the fixed wall bracket with variable adjustment. It is unique in its jointed design.



Design co-ordinated unit



Enables to **lift the door** and lock it in the main position



Glass is protected using the RAVAK AntiCalc® surface treatment technology

Quadrant Shower Enclosure

Shower Doors



CSKK4 - four-part quadrant shower enclosure

This frameless shower enclosure features practical rotary posts, which replace door hinges. Both doors can be opened and therefore offer exceptionally wide entry.

CSD1 - single shower door

The door opens both in and out, which makes airing of the enclosure after showering much easier. Water can drip inside the shower enclosure. The door cannot be combined with a fixed wall.

Recommended shower trays: Elipso, Elipso Pro, Elipso Pro Flat, Elipso Pro Chrome or a shower channel or drain

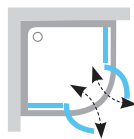

Recommended shower trays: Angela, Perseus, Perseus Pro, Perseus Pro Flat, Perseus Pro Chrome, Gigant Pro, Gigant Pro Flat, Gigant Pro Chrome or a shower channel or drain

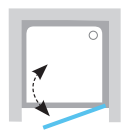

A bottom drip-ledge and a 10 mm high threshold strip ensure perfect sealing.



No more water dripping onto the floor thanks to the handy two-way door.

Product (type)	Entrance (mm)	Dimensions (mm)	Safety glass panel		
			Transparent decor Frame finish		
			Gloss	Satin	White
■ CSKK4 - 80	635	780-800x780-800	✓	✓	✓
■ CSKK4 - 90	635	880-900x880-900	✓	✓	✓

Product (type)	Entrance (mm)	Dimensions (mm)	Safety glass panel		
			Transparent decor Frame finish		
			Gloss	Satin	White
■ CSD1 - 80	635	775-805	✓	✓	✓
■ CSD1 - 90	755	875-905	✓	✓	✓

■ Height of the product is 1950 mm.
The products are as standard delivered within 14 days.

■ Height of the product is 1950 mm.
The products are as standard delivered within 14 days.



CSD2 - two-part shower door

The rotary post, which replaces door hinges, adds a unique stability and flexibility to the door while opening and closing. The door cannot be combined with a fixed wall.

Recommended shower trays: Perseus, Perseus Pro, Perseus Pro Chrome, Gigant Pro, Gigant Pro Flat, Gigant Pro Chrome or a shower channel or drain

Finish
GLOSS SATIN WHITE

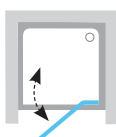
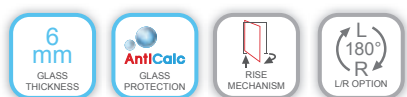

Optionally, your shower enclosure can be equipped with a bath water tap with a swinging spout which saves space and allows you to fill a bucket.

► see p. 238

Product (type)	Entrance (mm)	Dimensions (mm)	Safety glass panel		
			Transparent decor Frame finish		
			Gloss	Satin	White
■ CSD2 - 100	655	975-1005	✓	✓	✓
■ CSD2 - 110	655	1075-1105	✓	✓	✓
■ CSD2 - 120	655	1175-1205	✓	✓	✓

■ Height of the product is 1950 mm.
The products are as standard delivered within 14 days.



CSDL2 - two-part shower door

The swing door boasts exceptionally wide entry of up to 102 cm. It ensures perfect airing of the whole showering space. The door cannot be combined with a fixed wall.

Recommended shower trays: Angela, Perseus, Perseus Pro, Perseus Pro Flat, Perseus Pro Chrome, Gigant Pro, Gigant Pro Flat, Gigant Pro Chrome or a shower channel or drain

Finish
GLOSS SATIN WHITE

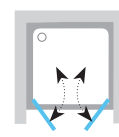

The CSD1, CSD2 and CSDL2 shower doors are designed to be used in a niche and therefore cannot be combined with a fixed wall.

Product (type)	Entrance (mm)	Dimensions (mm)	Safety glass panel		
			Transparent decor Frame finish		
			Gloss	Satin	White
■ CSDL2 - 90	720	875-905	✓	✓	✓
■ CSDL2 - 100	820	975-1005	✓	✓	✓
■ CSDL2 - 110	920	1075-1105	✓	✓	✓
■ CSDL2 - 120	1020	1175-1205	✓	✓	✓

■ Height of the product is 1950 mm.
The products are as standard delivered within 14 days.

Corner Shower Enclosures



CRV1 + CRV1 - shower door + shower door - corner entry

Combine two shower doors to obtain a square or rectangular shower enclosure. The door can be combined with a fixed wall.

CRV2 + CRV2 - shower door + shower door - corner entry

Combine two shower doors to obtain a square or rectangular shower enclosure. The door can be combined with a fixed wall.

Recommended shower trays: Angela, Perseus, Perseus Pro, Perseus Pro Flat, Perseus Pro Chrome, Gigant Pro, Gigant Pro Flat, Gigant Pro Chrome or a shower channel or drain

Finish
 GLOSS SATIN WHITE

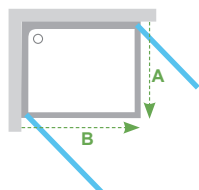
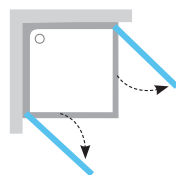

Possible combination:

A - CRV1 - choose dimensions 80 - 100 cm
 B - CRV1 - choose dimensions 80 - 100 cm

Recommended shower trays: Angela, Perseus, Perseus Pro, Perseus Pro Flat, Perseus Pro Chrome, Gigant Pro, Gigant Pro Flat, Gigant Pro Chrome or a shower channel or drain

Finish
 GLOSS SATIN WHITE

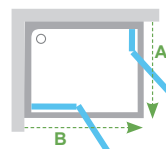
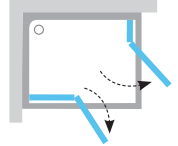

Possible combination:

A - CRV2 - choose dimensions 80 - 120 cm
 B - CRV2 - choose dimensions 80 - 120 cm

Product (type)	Entrance (mm)	Dimensions (mm)	Safety glass panel		
			Transparent decor Frame finish		
			Gloss	Satin	White
■ CRV1 - 80	969	780-800	✓	✓	✓
■ CRV1 - 90	1110	880-900	✓	✓	✓
■ CRV1 - 100	1251	980-1000	✓	✓	✓

Product (type)	Entrance (mm)	Dimensions (mm)	Safety glass panel		
			Transparent decor Frame finish		
			Gloss	Satin	White
■ CRV2 - 80	635	780-800	✓	✓	✓
■ CRV2 - 90	635	880-900	✓	✓	✓
■ CRV2 - 100	635	980-1000	✓	✓	✓
■ CRV2 - 110	710	1080-1100	✓	✓	✓
■ CRV2 - 120	710	1180-1200	✓	✓	✓

■ Height of the product is 1950 mm.
 The products are as standard delivered within 14 days.

■ Height of the product is 1950 mm.
 The products are as standard delivered within 14 days.

Chrome



This product is a combination of the CRV2 and CPS models.

CRV2 + CPS - shower door + fixed wall - front entry

You can also combine the shower door CRV1 or CRV2 with the fixed wall, next to which you can easily place a washbasin or washing machine.

Recommended shower trays: Angela, Perseus, Perseus Pro, Perseus Pro Flat, Perseus Pro Chrome, Gigant Pro, Gigant Pro Flat, Gigant Pro Chrome or a shower channel or drain

Finish: GLOSS SATIN WHITE

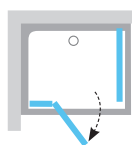

A rectangular shower enclosure will allow for the most comfortable showering. Consider whether you would prefer the size 80 x 100 cm to 90 x 90. It takes up the same area, but the utility is increased.

Product (type)	Dimensions (mm)	Safety glass panel		
		Transparent decor Frame finish		
		Gloss	Satin	White
■ CPS - 80	780-800	✓	✓	✓
■ CPS - 90	880-900	✓	✓	✓
■ CPS - 100	980-1000	✓	✓	✓

Usage possibilities:



Combine the shower door with another shower door or a fixed wall to obtain a square or rectangular shower enclosure tailored to your wishes. You can choose from these combinations:

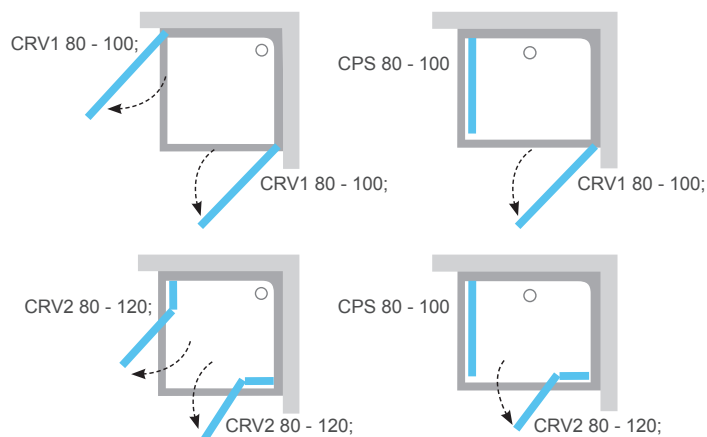

For the total cost: add the prices of both doors, or the door and the fixed wall, according to the chosen dimensions and colour.



The Chrome Concept offers a complete design solution for the entire bathroom.

► see p. 28

■ Height of the product is 1950 mm.
The products are as standard delivered within 14 days.







Rapier

A reliable enclosure with a charming design.

Rapier



Robust profiles – the contrast between a plain elegance of clear glass panels and a solid frame structure adds a unique appeal to the Rapier shower enclosure.

Space saving sliding system – the door doesn't open into the bathroom, therefore saving space. Nickel-cadmium surface finish provides the sliders' long service life.



Allows you to reach and clean difficult areas very easily



Silent run of your shower enclosure



Glass is protected using the RAVAK AntiCalc® surface treatment technology

Quadrant Shower Enclosure



NRKCP4 - four-part quadrant sliding shower enclosure

Features a distinctive style and design. Robust guiding profiles create an extraordinary solution out of this shower enclosure. The door tilt mechanism significantly simplifies maintenance of the whole showering space.

Recommended shower trays: Ronda, Elipso, Elipso Pro, Elipso Pro Flat, Elipso Pro Chrome or a shower channel or drain

Frame finish

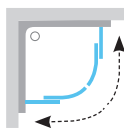
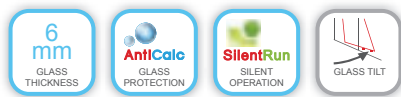

The Jet Inox hydro massage panel will intensify your showering experience.

▶ see p. 104

Product (type)	En-trance (mm)	Dimensions (mm)	Safety glass panel			
			Transparent decor		Grape decor	
			Frame finish		Frame finish	
			White	Satin	White	Satin
NRKCP4 - 80	425	775-795x775-795	✓	✓	✓	✓
NRKCP4 - 90	485	875-895x875-895	✓	✓	✓	✓
NRKCP4 - 100	485	975-995x975-995	✓	✓	✓	✓

Corner Shower Enclosures



NRKRV2 - four-part corner entry sliding shower enclosure

The most cost-effective shower enclosure of the Rapier range.

Recommended shower trays: Angela, Perseus, Perseus Pro, Perseus Pro Flat, Perseus Pro Chrome or a shower channel or drain

Frame finish

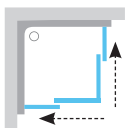

Product (type)	En-trance (mm)	Dimensions (mm)	Safety glass panel			
			Transparent decor		Grape decor	
			Frame finish		Frame finish	
			White	Satin	White	Satin
NRKRV2 - 80	425	770-790x770-790	✓	✓	✓	✓
NRKRV2 - 90	495	870-890x870-890	✓	✓	✓	✓
NRKRV2 - 100	565	970-990x970-990	✓	✓	✓	✓

■ Height of the product is 1900 mm.
The products are as standard delivered within 14 days.

■ Height of the product is 1900 mm.
The products are as standard delivered within 14 days.



The product is a combination of the NRDP4 and RPS models.

Usage possibilities:

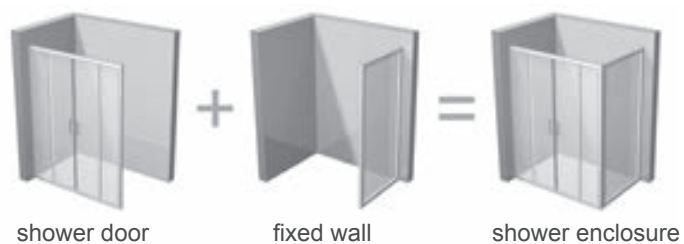

Combine the RPS fixed wall and chosen shower door to obtain a square or rectangular shower enclosure in different dimensions. You can choose from these combinations:

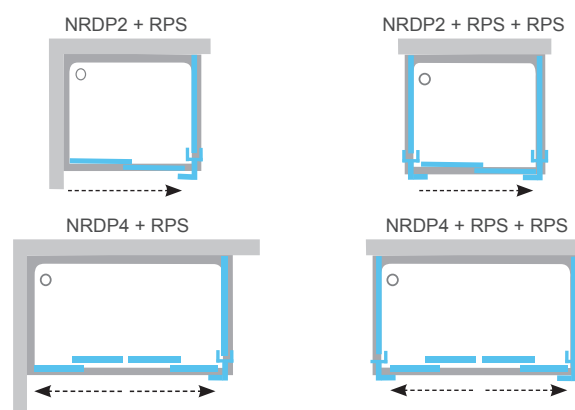

For the total cost: add the prices of the fixed wall and the shower door, according to the chosen dimensions.

NRDP4 + RPS - shower door + fixed wall - front entry

A shower enclosure tailored to your needs. Combine the shower door with fixed wall and create a showering space in dimensions from 100 x 80 cm up to 200 x 100 cm.

Recommended shower trays: Gigant Pro, Gigant Pro Flat, Gigant Pro Chrome or a shower channel or drain

Frame finish

SATIN WHITE



A rectangular shower enclosure will allow for the most comfortable showering. Consider whether you would prefer the size 80 x 100 cm to 90 x 90. It takes up the same rea, but the utility is increased.



The shower door and fixed wall used in the bathroom where there is enough space even for a washing machine.

Product (type)	Dimensions (mm)	Safety glass panel			
		Transparent decor		Grape decor	
		Frame finish		Frame finish	
		White	Satin	White	Satin
RPS - 80	770-790	✓	✓	✓	✓
RPS - 90	870-890	✓	✓	✓	✓
RPS - 100	970-990	✓■	✓■	✓■	✓■

■ Height of the product is 1900 mm.

■ Delivery takes 6 weeks.

The products are as standard delivered within 14 days.

Shower Doors



NRDP2 - two-part sliding shower door

Robust and wide. The door can seal a showering space in a width up to 120 cm. Choose the left or right hand option. The door cannot be reversed additionally.

Recommended shower trays: Perseus, Perseus Pro, Perseus Pro Flat, Perseus Pro Chrome, Gigant Pro, Gigant Pro Flat, Gigant Pro Chrome or a shower channel or drain

Frame finish

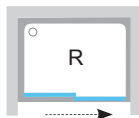
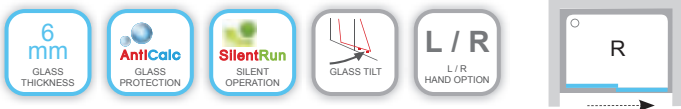

For more comfortable showering use our elegant shower seat available in different colour options.
▶ see p. 98

Product (type)	En-trance (mm)	Dimensions (mm)	Safety glass panel			
			Transparent decor		Grape decor	
			Frame finish		Frame finish	
NRDP2-100 L/R	395	970-1010	✓	✓	✓	✓
NRDP2-110 L/R	445	1070-1110	✓	✓	✓	✓
NRDP2-120 L/R	495	1170-1210	✓	✓	✓	✓

■ Height of the product is 1900 mm. L (left) - left hand product option. R - right hand product option. The products are as standard delivered within 14 days.



NRDP4 - four-part sliding shower door

The widest central entry shower door on the market. Combine the door and the RPS fixed wall to create a showering space in dimensions up to 100 x 200 cm.

Recommended shower trays: Gigant Pro, Gigant Pro Flat, Gigant Pro Chrome or a shower channel or drain

Frame finish

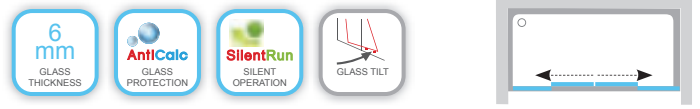

The Chrome shower channel will provide undisturbed floor design.
▶ see p. 130

Product (type)	En-trance (mm)	Dimensions (mm)	Safety glass panel			
			Transparent decor		Grape decor	
			Frame finish		Frame finish	
NRDP4-120	470	1170-1210	✓	✓	✓	✓
NRDP4-130	520	1270-1310	✓	■	✓	■
NRDP4-140	570	1370-1410	✓	■	✓	■
NRDP4-150	620	1470-1510	✓	■	✓	■
NRDP4-160	670	1570-1610	✓	■	✓	■
NRDP4-170	720	1670-1710	✓	■	✓	■
NRDP4-180	770	1770-1810	✓	■	✓	■
NRDP4-190	820	1870-1910	✓	■	✓	■
NRDP4-200	870	1970-2010	✓	■	✓	■

■ Height of the product is 1900 mm. ■ Delivery takes 6 weeks. The products are as standard delivered within 14 days.





NOW ALSO IN A
GLOSSY COLOUR

Pivot

Clean Lines and Modern Design



Pivot door-opening mechanism - a high-quality stainless steel hinge which rotates around its axis when the door opens. This is a simple unbreakable door-opening system, which requires absolutely no maintenance.

Ergonomic handle with three functions - turned downwards or sideways, the handle enables you to open the door comfortably. Turned upwards, it becomes a very practical towel-hanger.



Right / left hand option
Turn the product by 180 degrees.



Minimum profiles and no unreachable spots



Glass is protected using the RAVAK AntiCalc® surface treatment technology

Quadrant Shower Enclosure



PSKK3 - three-part quadrant pivot shower enclosure

Maximum design at minimum price. Impressive and keenly priced shower enclosure featuring elegant clear glass panels and subtle metal profiles.

Recommended shower trays: Ronda, Elipso, Elipso Pro, Elipso Pro Flat, Elipso Pro Chrome or a shower channel or drain

Frame finish
 GLOSS SATIN WHITE

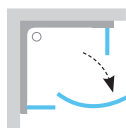

A shower enclosure with white frame comes in two designs: white or chromium-plated hinges and handles. A shower enclosure with satin frame features hinges and handles in satin finish.

Product (type)	Entrance (mm)	Dimensions (mm)	Safety glass panel		
			Transparent decor		
			Frame finish + pantu a madel		
			White + Chrom / White	Satin + Satin	Gloss + Chrome
■ PSKK3 - 80	490	770-795x770-795	✓	✓	✓
■ PSKK3 - 90	490	870-895x870-895	✓	✓	✓
■ PSKK3 - 100	490	970-995x970-995	✓ ■	✓ ■	✓ ■

- Height of the product is 1900 mm.
 - Delivery takes 6 weeks.
- The products are as standard delivered within 14 days.

Corner Shower Enclosure



Complete product - combination of PDOP2 and PPS.

PDOP2 + PPS - shower door + fixed wall - front entry

A shower enclosure tailored to your needs. Combine the shower door with fixed wall to create a showering space in dimensions from 80 x 80 cm up to 120 x 100 cm.

Recommended shower trays: Perseus Pro, Perseus Pro Flat, Perseus Pro Chrome, Gigant Pro, Gigant Pro Flat, Gigant Pro Chrome or a shower channel or drain

Frame finish
 GLOSS SATIN WHITE

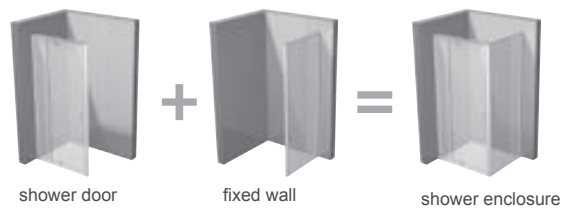
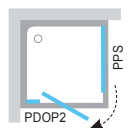

Product (type)	Dimensions (mm)	Safety glass panel		
		Transparent decor		
		Frame finish		
		White	Satin	Gloss
■ PPS - 80	770-795	✓	✓	✓
■ PPS - 90	870-895	✓	✓	✓
■ PPS - 100	970-995	✓	✓	✓

- Height of the product is 1900 mm.
- The products are as standard delivered within 14 days.



PDOP1 - single turning pivot shower door

Tailored to your wishes. Use the extension profiles (PNPS) to widen this product (and all products of this range as well) by 4 cm on each side.



PDOP2 - two-part turning pivot shower door

Even wider. Two-part shower door widths 100, 110 and 120 cm.

Recommended shower trays: Angela, Aneta, Perseus, Perseus Pro, Perseus Pro Flat, Perseus Pro Chrome, Gigant Pro, Gigant Pro Flat, Gigant Pro Chrome or a shower channel or drain

Frame finish
 GLOSS SATIN WHITE

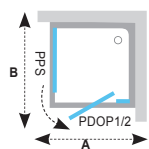
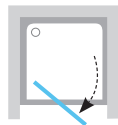

Create a showering space tailored to your needs, 120 x 100 cm for example.
A - shower door PDOP1 / PDOP2
 - choose dimensions 80 - 120 cm
B - fixed wall PPS
 - choose dimensions 80 - 100 cm

Recommended shower trays: Perseus, Perseus Pro, Perseus Pro Flat, Perseus Pro Chrome, Gigant Pro, Gigant Pro Flat, Gigant Pro Chrome or a shower channel or drain

Frame finish
 GLOSS SATIN WHITE

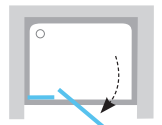

Extension profiles make it possible to extend the shower enclosure or door by 2 cm on each side.

▶ see p. 45

Product (type)	Entrance (mm)	Dimensions (mm)	Safety glass panel		
			Transparent decor		
			Frame finish + pantú a madel		
			White + Chrom / White	Satin + Satin	Gloss + Chrome
■ PDOP1 - 80	492	761-811	✓	✓	✓
■ PDOP1 - 90	592	861-911	✓	✓	✓

Product (type)	Entrance (mm)	Dimensions (mm)	Safety glass panel		
			Transparent decor		
			Frame finish + pantú a madel		
			White + Chrom / White	Satin + Satin	Gloss + Chrome
■ PDOP2 - 100	492	961-1011	✓	✓	✓
■ PDOP2 - 110	592	1061-1111	✓ ■	✓ ■	✓ ■
■ PDOP2 - 120	592	1161-1211	✓ ■	✓ ■	✓ ■

■ Height of the product is 1900 mm.
 The products are as standard delivered within 14 days.

■ Height of the product is 1900 mm.
 ■ Delivery takes 6 weeks.
 The products are as standard delivered within 14 days.



NOW WITH THE
GRAPHITE PANELS

Blix

Stylish and Technically Perfect



Balanced design - the appearance of the shower enclosure is not disturbed by any inner vertical profiles. It features solely glass screens and a subtle frame. Plain and practical handles enhance the balanced look.

Easy maintenance - the door wing tilt mechanism will allow you to reach and clean difficult areas very easily.



Frame assembly requires only a few screws.



Silent run of your shower enclosure



Glass is protected using the RAVAK AntiCalc® surface treatment technology

Quadrant Shower Enclosures



BLCP4 - four-part quadrant sliding shower enclosure

Space-saving and budget-wise. The shower enclosure features a glass panel with a reliable slider.

Recommended shower trays: Ronda, Elipso, Elipso Pro, Elipso Pro Flat, Elipso Pro Chrome or a shower channel or drain



Complement your new shower enclosure by the RAVAK thermostatic tap.

▶ see p. 244

Product (type)	Entrance (mm)	Dimensions (mm)	Safety glass panel						
			Transparent decor			Grape / Graphite decor			
			Frame finish			Frame finish			
			Gloss	Satin	White	Gloss	Satin	White	
■ BLCP4 - 80	490	775-795x775-795	✓	✓	✓	✓	✓	✓	✓
■ BLCP4 - 90	565	875-895x875-895	✓	✓	✓	✓	✓	✓	

■ Height of the product is 1900 mm.
The products are as standard delivered within 14 days.



SKCP4 Sabina - four-part quadrant sliding shower enclosure with a reduced height

A 'short' variant of the previous model. The shower enclosure is designed to be complemented by the Sabina mini-bath. It combines the advantages of baths and shower enclosures.

Recommended shower trays: Sabina

Frame finish

GLOSS SATIN WHITE

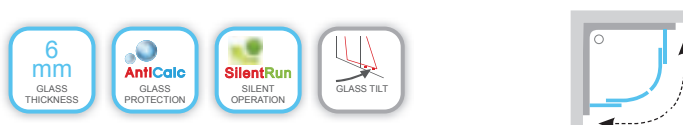

Do your children love taking baths? They can enjoy daily bathing even in a small bathroom thanks to the deep seating mini-bath.

Product (type)	Entrance (mm)	Dimensions (mm)	Safety glass panel						
			Transparent decor			Grape / Graphite decor			
			Frame finish			Frame finish			
			Gloss	Satin	White	Gloss	Satin	White	
■ BLCP4 - 80 Sabina	490	775-795x775-795	✓	✓	✓	✓	✓	✓	✓
■ BLCP4 - 90 Sabina	565	875-895x875-895	✓	✓	✓	✓	✓	✓	

■ Height of the product is 1750 mm.
The products are as standard delivered within 14 days.



BLRV2 - four part corner entry sliding shower enclosure

A square-shaped shower enclosure with a spacious corner entrance without a possibility of combining the dimensions.

Recommended shower trays: Angela, Perseus, Perseus Pro, Perseus Pro Flat, Perseus Pro Chrome or a shower channel or drain

Frame finish
 GLOSS SATIN WHITE

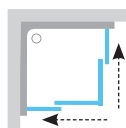
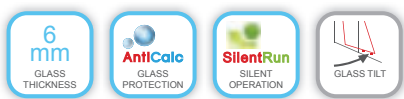

Use the SafeStep anti-slip strips or squares for safe movement in the bathroom.

▶ see p. 132

Product (type)	En-trance (mm)	Dimensions (mm)	Safety glass panel						
			Transparent decor			Grape / Graphite decor			
			Frame finish			Frame finish			
			Gloss	Satin	White	Gloss	Satin	White	
BLRV2 - 80	435	775-790x775-790	✓	✓	✓	✓	✓	✓	✓
BLRV2 - 90	500	875-890x875-890	✓	✓	✓	✓	✓	✓	

■ Height of the product is 1900 mm.
 The products are as standard delivered within 14 days.



BLRV2K and BLRV2K - four part corner entry sliding shower enclosure

To obtain a square-shaped or a rectangular-shaped shower enclosure with central entry, combine different dimensions of the BLRV2K product.

Recommended shower trays: Angela, Perseus, Perseus Pro, Perseus Pro Flat, Perseus Pro Chrome, Gigant Pro, Gigant Pro Flat, Gigant Pro Chrome or a shower channel or drain

Frame finish
 GLOSS SATIN WHITE

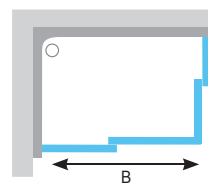
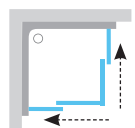

Possible combination:

A - BLRV2K - choose dimensions 80 - 120 cm
 B - BLRV2K - choose dimensions 80 - 120 cm
 (For more comfortable showering, choose for example 80 x 120 cm)

Product (type)	En-trance (mm)	Dimensions (mm)	Safety glass panel					
			Transparent decor			Grape / Graphite decor		
			Frame finish			Frame finish		
			Gloss	Satin	White	Gloss	Satin	White
■ BLRV2K - 80	435	780-800	✓	✓	✓	✓	✓	✓
■ BLRV2K - 90	500	880-900	✓	✓	✓	✓	✓	
■ BLRV2K - 100	575	980-1000	✓	✓	✓	✓	✓	
■ BLRV2K - 110	575	1080-1100	✓	✓	✓	✓	✓	
■ BLRV2K - 120	575	1180-1200	✓	✓	✓	✓	✓	

■ Height of the product is 1900 mm.
 The products are as standard delivered within 14 days.

Shower Doors



Panel - Graphite

BLDP2 - two-part sliding shower door

Tailored to your wishes. Use the extension profiles (BLNPS) to extend this product by up to 4 cm on each side. Turning the product round will give you the left or right hand side option.

Recommended shower trays: Perseus, Perseus Pro, Perseus Pro Flat, Perseus Pro Chrome, Gigant Pro, Gigant Pro Flat, Gigant Pro Chrome or a shower channel or drain

Frame finish
 GLOSS SATIN WHITE

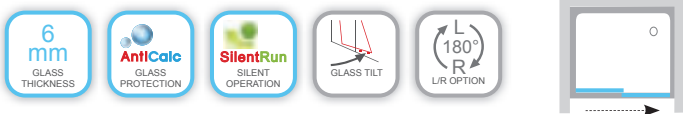

The BLNPS extension profile. Price CZK 310 / 360 / 360 (according to finish - white / satin / gloss). Can be used for all Blix products. (except for BLDP4).

► see p. 45

Product (type)	Entrance (mm)	Dimensions (mm)	Safety glass panel						
			Transparent decor			Grape / Graphite decor			
			Frame finish			Frame finish			
			Gloss	Satin	White	Gloss	Satin	White	
■ BLDP2 -100;	410	970-1010	✓	✓	✓	✓	✓	✓	✓
■ BLDP2 -110;	460	1070-1110	✓	✓	✓	✓	✓	✓	
■ BLDP2 -120;	510	1170-1210	✓	✓	✓	✓	✓	✓	



Panel - Grape

BLDP4 - four-part sliding shower door

The widest central entry shower door on the market. Combine it with the BLPS fixed wall to create a showering space in dimensions up to 100 x 200 cm.

Recommended shower trays: Gigant Pro, Gigant Pro Flat, Gigant Pro Chrome or a shower channel or drain

Frame finish
 GLOSS SATIN WHITE

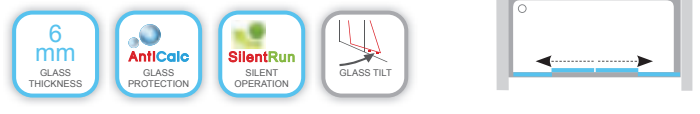

Product (type)	Entrance (mm)	Dimensions (mm)	Safety glass panel					
			Transparent decor			Grape / Graphite decor		
			Frame finish			Frame finish		
			Gloss	Satin	White	Gloss	Satin	White
■ BLDP4 -120;	493	1170-1210	✓	✓	✓	✓	✓	✓
■ BLDP4 -130;	543	1270-1310	✓	✓	✓	✓	✓	
■ BLDP4 -140;	593	1370-1410	✓	✓	✓	✓	✓	
■ BLDP4 -150;	643	1470-1510	✓	✓	✓	✓	✓	
■ BLDP4 -160;	693	1570-1610	✓	✓	✓	✓	✓	
■ BLDP4 -170;	743	1670-1710	✓	✓	✓	✓	✓	
■ BLDP4 -180;	793	1770-1810	✓	✓	✓	✓	✓	
■ BLDP4 -190;	843	1870-1910	✓	✓	✓	✓	✓	
■ BLDP4 -200;	893	1970-2010	✓	✓	✓	✓	✓	

■ Height of the product is 1900 mm. ■ Delivery takes 6 weeks. The products are as standard delivered within 14 days.

■ Height of the product is 1900 mm. The products are as standard delivered within 14 days.



The product is a combination of the BLDP2 and BLPS models.

BLDP2 + BLPS - shower door + fixed wall - front entry

A corner shower enclosure tailored to your wish. Combine the shower door with fixed wall to create a showering space in dimensions from 100 x 80 cm up to 120 x 100 cm.

Recommended shower trays: Perseus, Perseus Pro, Perseus Pro Flat, Perseus Pro Chrome, Gigant Pro, Gigant Pro Flat, Gigant Pro Chrome or a shower channel or drain

Frame finish
 GLOSS SATIN WHITE

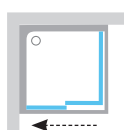

The Runway shower channel will provide undisturbed floor design.

► see p. 130

Usage possibilities:

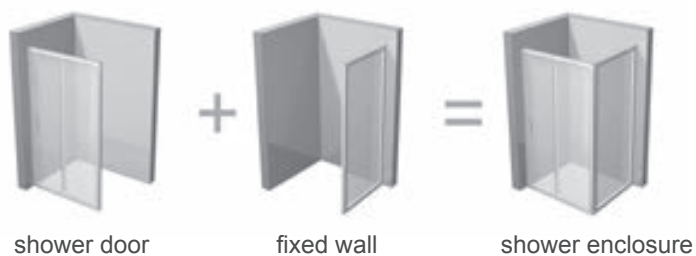

Combine the BLPS fixed wall and the selected shower door to obtain a square or rectangular shower enclosure in various dimensions. You can choose from these combinations:

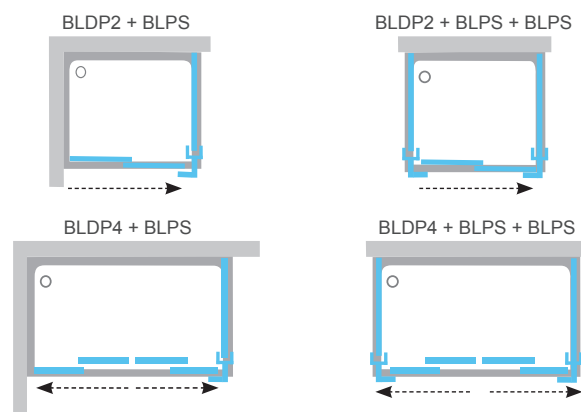

For the total cost: add the prices of the fixed wall and the shower door, according to the chosen dimensions.

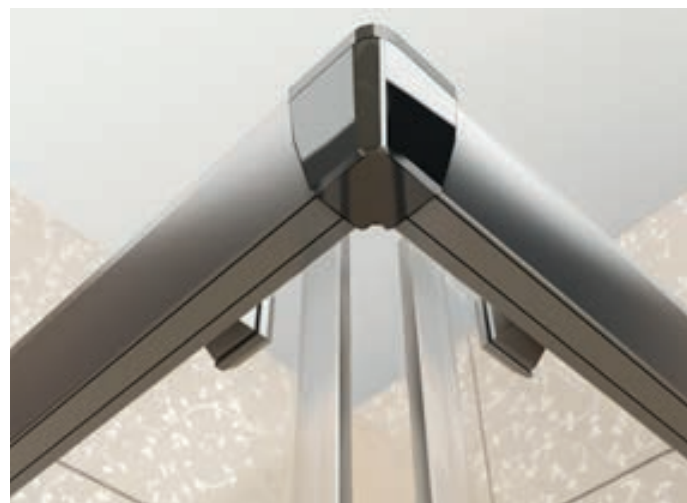

Safety glass panel

Product (type)	Dimensions (mm)	Safety glass panel					
		Transparent decor			Grape / Graphite decor		
		Frame finish			Frame finish		
		Gloss	Satin	White	Gloss	Satin	White
■ BLPS - 80	770-790	✓	✓	✓	✓	✓	✓
■ BLPS - 90	870-890	✓	✓	✓	✓	✓	✓
■ BLPS - 100	970-990	✓	✓	✓	✓	✓	✓

■ Height of the product is 1900 mm.

The products are as standard delivered within 14 days.



Supernova
Absolute Reliability

Supernova



Trouble-free and silent operation - AntiBlock mechanism prevents sliding parts from crossing or getting jammed, thus ensuring smooth operation of your shower enclosure. The tested life span is 1,000,000 opening cycles.

The widest range of models - this range offers 10 models of shower enclosures, doors, fixed screens and a special short shower enclosure designed for a mini-bath. It features two frame finish options and three types of panels.



Very easy installation
Comes in an assembled state



Glass is protected using the RAVAK AntiCalc® surface treatment technology



10 year AntiBlock warranty
We provide a 10-year warranty on the AntiBlock mechanism

Quadrant Shower Enclosures



SKCP4 - four-part quadrant sliding shower enclosure

The best selling framed shower enclosure. It features a durable frame structure and high-quality surface finish.

Recommended shower trays: Ronda, Elipso, Elipso Pro, Elipso Pro Flat, Elipso Pro Chrome, Sabina or a shower channel or drain

Frame finish

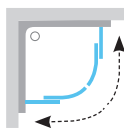

AntiBlock - a lifelong promise of smooth and silent operation of your shower enclosure. The AntiBlock mechanism is provided with a 10-year guarantee.

Product (type)	Entrance (mm)	Dimensions (mm)	Plastic panel		Safety glass panel			
			Pearl decor		Transparent decor		Grape decor	
			Frame finish		Frame finish		Frame finish	
			White	Satin	White	Satin	White	Satin
■ SKCP4 - 80	500	775-795x775-795	✓	✓	✓	✓	✓	✓
■ SKCP4 - 90	550	875-895x875-895	✓	✓	✓	✓	✓	✓

■ Height of the product is 1850 mm.
The products are as standard delivered within 14 days.



SKCP4 Sabina - four-part quadrant sliding shower enclosure with a reduced height

A 'short' variant of the previous model. The shower enclosure is designed to be complemented by the Sabina mini-bath. It combines the advantages of baths and shower enclosures.

Recommended shower trays: Sabina

Frame finish

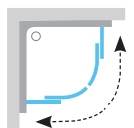

Do your children love taking baths? They can enjoy daily bathing even in a small bathroom thanks to the deep seating mini-bath.

Product (type)	Entrance (mm)	Dimensions (mm)	Plastic panel	
			Pearl decor	
			Frame finish	
			White	Satin
■ SKCP4 - 80 Sabina	500	775-795x775-795	✓	✓
■ SKCP4 - 90 Sabina	550	775-795x775-795	✓	✓

■ Height of the product is 1700 mm.
The products are as standard delivered within 14 days.



SKKP6 - a six-part quadrant sliding shower enclosure

The best value quadrant shower enclosure of the RAVAK range. Thanks to the straight panels divided into six parts, it ensures absolute indestructibility.

Recommended shower trays: Ronda, Elipso, Elipso Pro, Elipso Pro Flat, Elipso Pro Chrome, Sabina or a shower channel or drain

Frame finish

WHITE

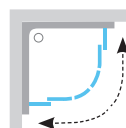

Absolutely waterproof - the structural design of the glass panels won't allow water to leak.



Enjoy more comfort in your shower enclosure. For seats, see p. 98

Product (type)	En-trance (mm)	Dimensions (mm)	Plastic panel		Safety glass panel			
			Frame finish		Frame finish		Frame finish	
			White	Satin	White	Satin	White	Satin
■ SKKP6 - 80	460	775-795x775-795	✓	—	✓	—	✓	—
■ SKKP6 - 90	550	875-895x875-895	✓	—	✓	—	✓	—

■ Height of the product is 1850 mm.

The products are as standard delivered within 14 days.

Corner Shower Enclosures



The product is a combination of the SRV2-S and SRV2-S.



The product is a combination of the ASRV3 and ASRV3 models in the Pearl decor.

SRV2-S + SRV2-S - four-part corner entry sliding shower enclosure

The most advantageous shower enclosure of the Supernova range. To obtain a square-shaped or a rectangular-shaped shower enclosure, combine different dimensions of the SRV2-S product.

Recommended shower trays: Aneta, Angela, Perseus, Perseus Pro, Perseus Pro Flat, Perseus Pro Chrome, Gigant Pro, Gigant Pro Flat, Gigant Pro Chrome or a shower channel or drain

Frame finish

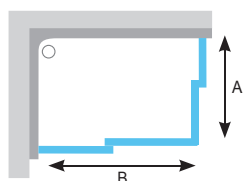
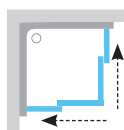

Possible combination:

A - SRV2-S - choose dimensions 75 - 100 cm
B - SRV2-S - choose dimensions 75 - 100 cm
(For more comfortable showering, choose for example 80 x 100 cm)

Product (type)	En-trance (mm)	Dimensions (mm)	Plastic panel		Safety glass panel					
			Pearl decor		Transparent decor		Grape decor			
			Frame finish		Frame finish		Frame finish			
White	Satin	White	Satin	White	Satin	White	Satin			
SRV2-S - 75	396	720 - 740	✓	—	✓	■	—	✓	■	—
SRV2-S - 80	431	770 - 790	✓	—	✓	—	—	✓	—	—
SRV2-S - 90	504	870 - 890	✓	✓	✓	✓	—	✓	✓	—
SRV2-S - 100	530	970 - 990	✓	—	✓	■	—	✓	■	—

■ Height of the product is 1850 mm.

■ Delivery takes 6 weeks.

Note: Each part comes as an individual product. To assemble the whole corner shower enclosure, two pieces are needed. The products are as standard delivered within 14 days.

ASRV3 + ASRV3 - six-part corner entry sliding shower enclosure

It features the widest entry of all Supernova corner shower enclosures. To obtain a square-shaped or a rectangular-shaped shower enclosure, combine different dimensions of the ASRV3 product.

Recommended shower trays: Aneta, Angela, Perseus, Perseus Pro, Perseus Pro Flat, Perseus Pro Chrome or a shower channel or drain

Frame finish

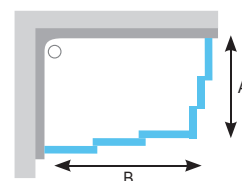
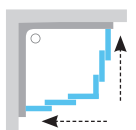

Possible combination:

A - ASRV3 - choose dimensions 75 - 90 cm
B - ASRV3 - choose dimensions 75 - 90 cm

Product (type)	En-trance (mm)	Dimensions (mm)	Plastic panel		Safety glass panel					
			Pearl decor		Transparent decor		Grape decor			
			Frame finish		Frame finish		Frame finish			
White	Satin	White	Satin	White	Satin	White	Satin			
ASRV3 - 75	495	720 - 740	3 990	—	✓	■	—	✓	■	—
ASRV3 - 80	543	770 - 790	3 990	—	✓	—	—	✓	—	—
ASRV3 - 90	635	870 - 890	4 190	—	✓	—	—	✓	—	—

■ Height of the product is 1880 mm.

■ Delivery takes 6 weeks.

Note: Each part comes as an individual product. To assemble the whole corner shower enclosure, two pieces are needed. The products are as standard delivered within 14 days.

Supernova



ASDP3 + APSS - shower door + fixed wall - front entry

A shower enclosure tailored to your needs. Combine a shower door and a fixed wall to create a showering space in dimensions up to 120 x 90 cm.

Recommended shower trays: Aneta, Angela, Perseus, Perseus Pro, Perseus Pro Flat, Perseus Pro Chrome, Gigant Pro, Gigant Pro Flat, Gigant Pro Chrome or a shower channel or drain



Frame finish

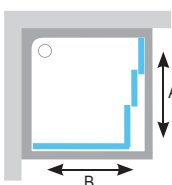
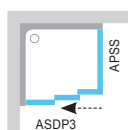

Create your own showering space according to your wish, for example: 120 x 90 cm.

A - shower door ASDP3 - choose dimensions 80 - 130 cm
B - fixed wall APSS - choose dimensions 75 - 90 cm

Product (type)	Dimensions (mm)	Plastic panel		Safety glass panel			
		Frame finish		Frame finish		Frame finish	
		White	Satin	White	Satin	White	Satin
■ APSS - 75	720 - 755	✓	✓	✓	✓	✓	✓
■ APSS - 80	770 - 805	✓	✓	✓	✓	✓	✓
■ APSS - 90	870 - 905	✓	✓	✓	✓	✓	✓
■ PSS - 75	720 - 755	✓	—	✓	—	✓	—
■ PSS - 80	770 - 805	✓	—	✓	—	✓	—
■ PSS - 90	870 - 905	✓	—	✓	—	✓	—

- Height of the product is 1880 mm.
- Height of the product is 1850 mm.

The products are as standard delivered within 14 days.

Usage possibilities:

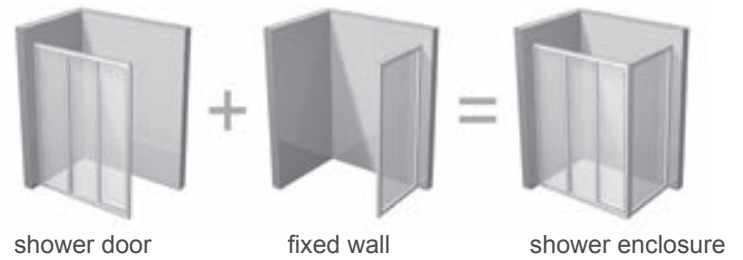

Combine the APSS or PSS fixed wall and the chosen shower door to obtain a shower enclosure tailored to your bathroom. You can choose from these combinations:

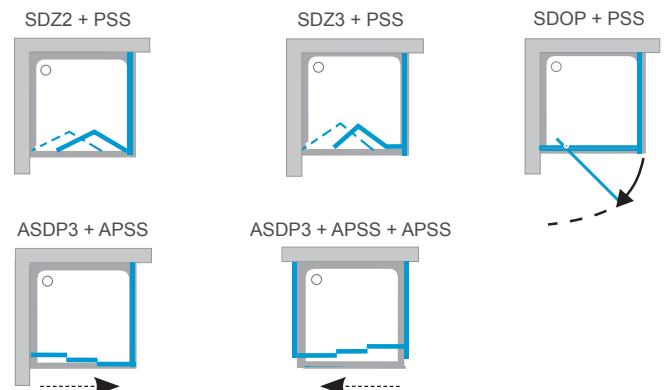

For the total cost: add the prices of the fixed wall and the shower door, according to the selected size and type.

The SDZ2, SDZ3 and SDOP shower doors can be combined with the PSS fixed walls only.
The ASDP3 shower doors are compatible with the APSS fixed walls only.



If you use the shower door with fixed wall, you can easily place a washing machine next to the shower enclosure.

Shower Doors



ASDP3 - three-part sliding shower door

Extremely durable, practically unbreakable shower door. Ideal solution also for busy public areas (hotel, hostels, hospitals and such).

SDZ2 - two-part folding shower door

Suited to the smallest rooms in dimensions of 67 - 71 cm. The folding door enables the maximum entrance width.

Recommended shower trays: Aneta, Angela, Perseus, Perseus Pro, Perseus Pro Flat, Perseus Pro Chrome, Gigant Pro, Gigant Pro Flat, Gigant Pro Chrome or a shower channel or drain

Frame finish



We recommend: Install the product directly onto the floor with a built-in mini shower channel or drain.

Frame finish

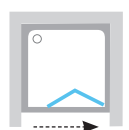

T/AT profile (White / satin)

A connecting profile intended for attaching several shower enclosures or doors in a row divided by fixed walls together. Suitable for use in public shower areas.



The SDZ2, SDZ3 and SDOP shower doors can be combined with the PSS fixed walls only. The ASDP3 shower doors are compatible with the APSS fixed walls only.

Product (type)	En-trance (mm)	Dimensions (mm)	Plastic panel		Safety glass panel			
			Pearl decor		Transparent decor		Grape decor	
			White	Satin	White	Satin	White	Satin
ASDP3 - 80	395	770 - 810	✓	✓	✓	✓	✓	✓
ASDP3 - 90	461	870 - 910	✓	✓	✓	✓	✓	✓
ASDP3 - 100	528	970 - 1010	✓	✓	✓	✓	✓	✓
ASDP3 - 110	595	1070 - 1110	✓	—	✓	—	✓	—
ASDP3 - 120	661	1170 - 1210	✓	—	✓	—	✓	—
ASDP3 - 130	728	1270 - 1310	✓	—	✓	—	✓	—

■ Height of the product is 1880 mm.

■ Delivery takes 6 weeks.

The products are as standard delivered within 14 days.

Product (type)	En-trance (mm)	Dimensions (mm)	Plastic panel		Safety glass panel			
			Pearl decor		Transparent decor		Grape decor	
			White	Satin	White	Satin	White	Satin
SDZ2 - 70	492	670 - 710	✓	—	✓	—	✓	—

■ Height of the product is 1850 mm.

The products are as standard delivered within 14 days.



SDZ3 - three-part folding shower door

A wider version of the previous model. Suitable for bathrooms in widths of 77 - 101 cm.



SDOP - turning pivot shower door

This is the simplest construction variant of shower door in this range and therefore the best value.

Recommended shower trays: Aneta, Angela, Perseus, Perseus Pro, Perseus Pro Flat, Perseus Pro Chrome, Gigant Pro, Gigant Pro Flat, Gigant Pro Chrome or a shower channel or drain



Frame finish

WHITE



Some centimetres missing? Use extension profiles see p. 45. instead of paying extra money for a custom-made product.

Product (type)	En-trance (mm)	Dimensions (mm)	Plastic panel		Safety glass panel			
			Frame finish		Frame finish		Frame finish	
			White	Satin	White	Satin	White	Satin
SDZ3 - 80	510	770 - 810	✓	—	✓	—	✓	—
SDZ3 - 90	610	870 - 910	✓	—	✓	—	✓	—
SDZ3 - 100	610	970 - 1010	✓	—	✓	■	✓	■

■ Height of the product is 1850 mm.
 ■ Delivery takes 6 weeks.
 The products are as standard delivered within 14 days.

Recommended shower trays: Aneta, Angela, Perseus, Perseus Pro, Perseus Pro Flat, Perseus Pro Chrome, Gigant Pro, Gigant Pro Flat, Gigant Pro Chrome or a shower channel or drain



Frame finish

WHITE

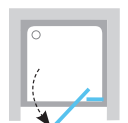

Invisible grease. Recommended for all RAVAK products.

▶ see p. 259

Product (type)	En-trance (mm)	Dimensions (mm)	Plastic panel		Safety glass panel			
			Frame finish		Frame finish		Frame finish	
			White	Satin	White	Satin	White	Satin
SDOP - 80	485	773 - 810	✓	—	✓	—	✓	—
SDOP - 90	485	873 - 910	✓	—	✓	—	✓	—
SDOP - 100	485	973 - 1010	✓	■	✓	■	✓	■

■ Height of the product is 1850 mm.
 ■ Delivery takes 6 weeks.
 The products are as standard delivered within 14 days.

Seats and hydro massage panels

Relaxation available any time

*Showering does not need to be mere quick wash in everyday routine.
Enjoy showering as you like it. Sit down and relax.*



Chrome



Chrome with white frame (folded up)



Chrome with stainless steel frame (folded up)

New design in proven quality

Favourite group the RAVAK seats is newly widened by the design close to the Chrome concept

- they will fit perfectly into the bathroom in the Chrome concept, but will look nice elsewhere
- they adhere to the high quality of shower seats
- two frame colour options available

The seats are suitable for shower areas larger than 90 x 90 cm at 45 cm over the floor.



Product (type)	Dimensions (mm)	Colour	Price
Chrome - white frame	410x375	translucent white with white oval	✓
Chrome - stainless steel frame	410x375	translucent white with white oval	✓

Product dimensions: width x depth
The products are as standard delivered within 14 days.

Ovo B



Ovo B clear

Ovo B opal

It can be folded up to the wall.

Ovo P

Seats

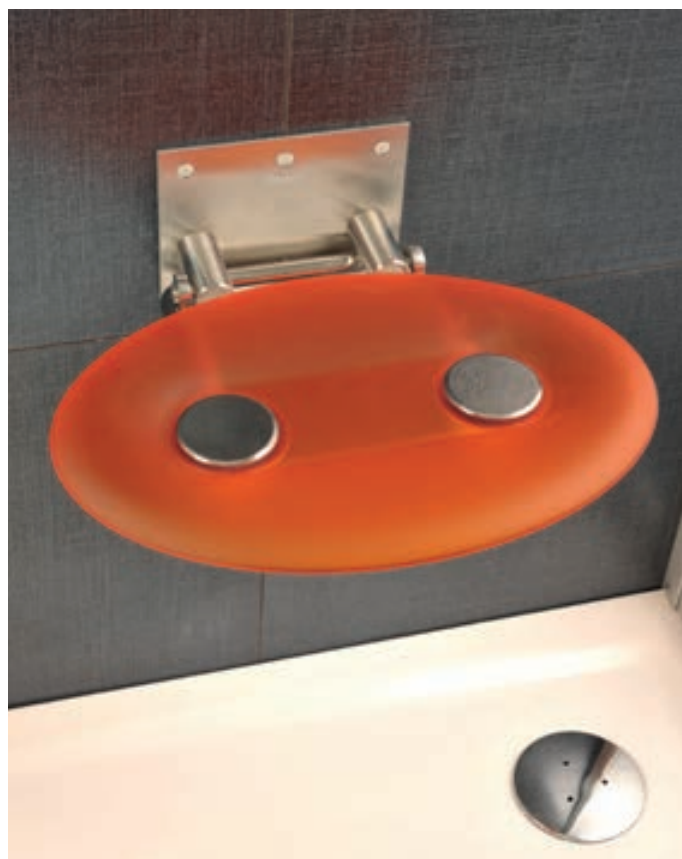

Ovo P clear

Ovo P opal

It can be folded up to the wall.

- **Compact** - they can be folded back against the wall, occupy only 10 cm
- **Durable** - stainless steel construction stands up in the interior, but also in the exterior
- **Robust** - can carry up to 150 kg
- **Proven** - tens of thousands of satisfied customers
- **Easy installation**



Practical item that makes everyday wash easy.

Product (type)	Dimensions (mm)	Colour	Price
Ovo B clear	360x360	clear	✓
Ovo B opal	360x360	translucent white	✓
Ovo B orange	360x360	translucent orange	✓

Product (type)	Dimensions (mm)	Colour	Price
Ovo P clear	410x350	clear	✓
Ovo P opal	410x350	translucent white	✓
Ovo P orange	410x350	translucent orange	✓

Product dimensions: width x depth
The products are as standard delivered within 14 days.

Seats for all occasions



bathroom

Relaxation and comfort in the bathroom.



Makes leg shaving easier.



interior

Makes putting on shoes easier.



exterior

The seat can be fit even on a narrow balcony.



Ovo B Decor - Blueline (folded up)



Ovo B Decor - Text (folded up)

Design seats are mainly suitable for:

- narrow entrance halls and corridors for putting on shoes
- on a balcony when relaxing
- in public areas and recreation facilities

**Take a seat in a place,
which is too small
for a chair**



Product (type)	Dimensions (mm)	Colour	Price
Ovo B Decor - Blueline	360x360	translucent white with blue strips	✓
Ovo B Decor - Text	360x360	translucent white with black letters	✓

Product dimensions: width x depth
The products are as standard delivered within 14 days.

Hydro Massage Panels



Jet Inox

Impressive stainless steel for a luxurious look and uncompromising quality. Three zones of circumferentially spaced jets, shower head and waterfall feature at the top of the panel to ensure an unforgettable experience.

Jet Glass

The glass design looks fragile and subtle in stark contrast to the strength of experience during showering. Eight swivel massage jets for the whole body and a shower head.

Jet

Jet Panel has a proven design and it features a large-scale fixed shower and a two-position massage jet with adjustable flow direction and a hand shower with 3 modes.



Fixed shower head and waterfall



Large shower head



Protected against clogging with limescale

Product (type)	Dimensions (mm)	Price
Jet Inox	260x1610	✓
Jet Glass	270x1500	✓
Jet	290x1450	✓

All hydro massage panels are equipped with a thermostatic tap

Delivery takes 21 days.

Hydro Massage Panels





Shower Trays, Shower Channels and Drains

*Many solutions
of shower enclosure floors*

*Do you want your ceramic tile effect on the floor or do you prefer smooth beauty
of the shower tray? Choose and enjoy everyday comfort in the shower.*



RAVAK Shower Trays

Each of the six product lines has its own specific characteristics.
Will you choose a proven classic or an impressive flat design?

GALAXY Pro Chrome

Cast shower trays featuring rounded inner edges in the Chrome range design

► p. 112



Elipso Pro Chrome

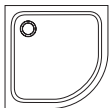

Perseus Pro Chrome



Gigant Pro Chrome

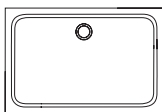

Material:

cast mixture of dolomite and resin

Production process:

casting



GALAXY Pro

Cast shower trays a slip-resistant surface

► p. 114



Elipso Pro

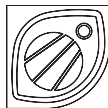

Perseus Pro



Gigant Pro

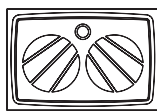

Material:

cast mixture of dolomite and resin

Production process:

casting



GALAXY Pro Flat

Cast shower trays with a flat bottom

► p. 116



Elipso Pro Flat

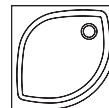

Perseus Pro Flat

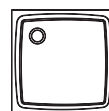

Gigant Pro Flat

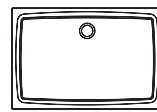

Material:

cast mixture of dolomite and resin

Production process:

casting



Deep seating MINI-BATH

Shower tray with features of a bath.

► p. 118



Sabina

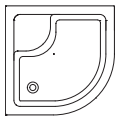

Material:
PMMA + ABS sandwich, Antibac®
Reinforcement:
LA type - fibreglass

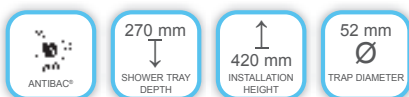

GALAXY

Flat shower trays in modern design.

► p. 120



Elipso

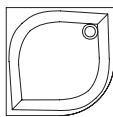

Perseus

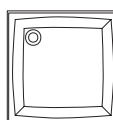

Material:
PMMA + ABS sandwich, Antibac®
Reinforcement:
LA type - fibreglass
EX, PU type - polyurethane foam with glass fibre

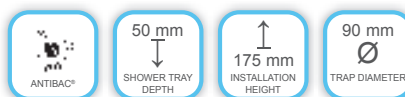

KASKADA

Shower trays proven by customers' experience at a convenient price.

► p. 122



Ronda

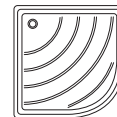

Angela

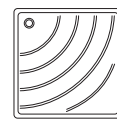

Aneta

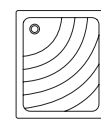

Material:
PMMA + ABS sandwich, Antibac®
Reinforcement:
LA type - fibreglass
EX, PU type - polyurethane foam with glass fibre

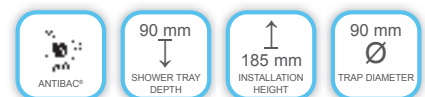

Shower Tray Installation

The construction of shower trays is divided into several types. Each type is installed in a different manner.

1) LA, LA+Base, LA+Base+Set types and cast shower trays should be installed on a base or directly onto the floor

LA type



Galaxy

- to be embedded into the floor
- designed for underpinning
- on a base

LA type shower trays consist of a laminate layer, reinforcement and an acrylic shell. Front covering panel is not included

LA, LA + Base, LA + Base + Set types



Sabina mini-bath

- LA type - designed for underpinning and encasing
- LA + Base type – to be installed on a base
- LA + Base + Set type – for installation on a base with a panel

Sabina deep seating shower trays consist of a laminate layer, reinforcement and an acrylic shell. Supportive legs and the front covering panel need to be purchased separately.

Cast shower trays



Galaxy Pro (Flat, Chrome)

- To be glued directly onto the floor
- installation on a base
- installation on a base with a panel

The Galaxy Pro, Galaxy Pro Flat and Galaxy Pro Chrome trays are cast shower trays made of ground dolomite and polyester resin, formed by "pure casting" technology. Neither the front covering panel (Set) nor the supportive legs (Base) are included with the tray; they need to be purchased separately.



Installation of shower tray on the floor, base and installation of self-supporting trays can be found at www.ravak.com:

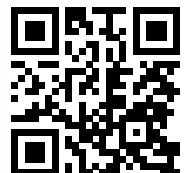

2) PU, PP, PAN and EX type shower trays are self-supporting.

PU type



Kaskada

- self-supporting
- with an integrated front covering panel

A PU type shower tray consists of an acrylic shell and a polyurethane foam support reinforced with a glass-fibre mat. The PU tray is self-supporting and moulded together with the front panel. Installation of a PU shower tray often takes just a couple of minutes and this type belongs to the best value and least challenging trays.

PP type

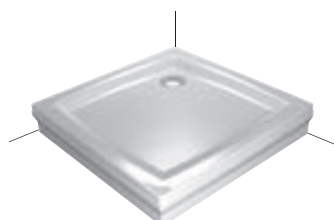

Galaxy

- self-supporting
- necessary to purchase a suitable panel type

PP type shower trays use a separable-front-panel system. There are "N" panel types (for trays installed into a niche), and "L" panel types for trays installed in a common way into a bathroom corner. Because of large variability, the front panels are sold individually, i.e. they are not included in the price of the shower tray. There are construction differences between the supports of the EX and PP shower trays. Panels designed for PP trays are not compatible with the EX shower tray models.

PAN type



Galaxy

- self-supporting
- with the front covering panel included

PAN type shower trays consist of two separable parts: the tray itself and a front panel to be mounted on the polyurethane support. With this type, the front panel is included in the delivery package with the tray, as well as in the price.

EX type



Galaxy

- self-supporting
- intended for tiling

EX type shower trays consist of a polyurethane foam support and an acrylic shell. They differ from the PU type in the acrylic shell design. The EX type shell is trimmed to enable tiling of the tray with common tiling materials. The tiles can be fitted straight onto the body of the tray support.

What makes the PU, EX, PP and PAN self-supporting shower trays unique?

High rigidity - guarantee of durability

The exclusive rigid polyurethane support provides 100% stability of the shower tray.

Shape stability - the tray does not sag or squeak

Following the top technology of high-pressure casting with the use of fibreglass, we obtained a material which will retain its shape throughout its lifelong use. Even with frequent use the tray will stay rigid and will serve you for a long time without problems.

Quick and easy installation

All you need for perfect installation and facing of the tray is one tube of RAVAK Professional sanitary silicon. No "wet" building process by which the tray gets so easily scratched.

Perfect draining

All new shower trays feature 90 mm diameter waste traps with 30 litres per minute flow volume, which fulfils even the highest requirements.

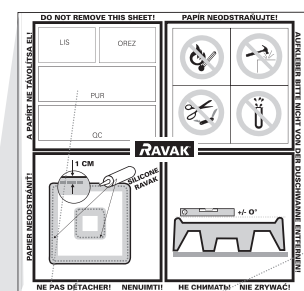

Each tray comes out individually labelled for easy and clear identification.

Shower Trays

Galaxy Pro Chrome

Low and smooth shower trays of cast marble



Easy maintenance thanks to the smooth bottom of the shower tray.

Linked to the concept

The shower tray bottom reflects the characteristic feature of the Chrome range - an oval shape in a form of rounded corners.

Extra flat design

Low and flat bottom makes the maintenance of the shower tray much easier.

Easy-access solution

Due to their thickness of 30 mm, these shower trays are ideal for walk-in access achieved by embedding them into the floor.



Embedded into the floor

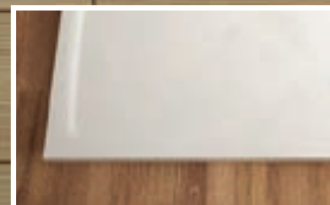

Glued directly onto the floor

Galaxy Pro Chrome Shower Trays

Elipso Pro Chrome 80, 90



Galaxy Pro Chrome tray type	Price
Elipso Pro Chrome 80	✓
Elipso Pro Chrome 90	✓
SET (panel + panelkit)	Price
Elipso Pro 80 SET	✓
Elipso Pro 90 SET	✓
BASE (supportive legs)	Price
Base Galaxy Pro	✓

Suitable for:

SKCP4 80, 90; SKKP6 80, 90;
BLCP4 80, 90; NRKCP4 80, 90, 100;
PSK3 80, 90; CSK4 80, 90;
SMSK4 80, 90;
BSK3 80, 90; BSK4 80, 90

Perseus Pro Chrome 80, 90, 100



Galaxy Pro Chrome tray type	Price
Perseus Pro Chrome 80	✓
Perseus Pro Chrome 90	✓
Perseus Pro Chrome 100	✓
SET (panel + panelkit)	Price
Perseus Pro 80 SET	✓
Perseus Pro 90 SET	✓
Perseus Pro 100 SET	✓
BASE (supportive legs)	Price
Base Galaxy Pro	✓

Suitable for:

SRV2-S + SRV2-S 80, 90, 100;
ASRV3 + ASRV3 80, 90; BLRV2 80,90
BLRV2K + BLRV2K 80, 90, 100;
NRKR2 80, 90, 100; CRV1 80, 90, 100;
CRV2 80, 90, 100; SMSRV4 80, 90;
BSRV4 80, 90, 100; BSDPS 80, 90, 100;
MSRV4 80, 90, 100;

and shower areas with shower doors
ASDP3 80, 90, 100; SDZ3 80, 90, 100;
SDOP 80, 90, 100; BLDP2 100; PDOP1
80, 90; PDOP2 100;
CSD1 80, 90; CSD2 100;
CSDL2 90, 100; SMSD2 90, 100;
BSD2 80, 90, 100; MSD2 100;

Gigant Pro Chrome 100 x 80, 110 x 80, 120 x 80, 120 x 90

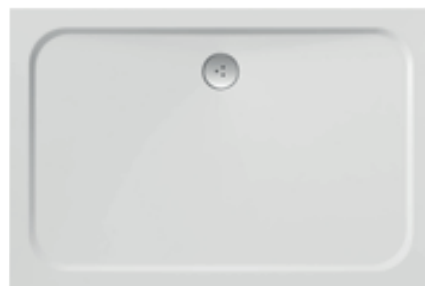

Galaxy Pro Chrome tray type	Price
Gigant Pro Chrome 100 x 80	✓
Gigant Pro Chrome 110 x 80	✓
Gigant Pro Chrome 120 x 80	✓
Gigant Pro Chrome 120 x 90	✓
SET (panel + panelkit)	Price
Gigant Pro 100 x 80 SET L/R	✓
Gigant Pro 110 x 80 SET L/R	✓
Gigant Pro 120 x 80 SET L/R	✓
Gigant Pro 120 x 90 SET L/R	✓
BASE (supportive legs)	Price
Base Galaxy Pro	✓

Suitable for:

Gigant Pro 100 x 80

SRV2-S 100 + SRV2-S 80; SDZ3 100 + PSS 80;
SDOP 100 + PSS 80; ASDP3 100 + APSS 80;
BLRV2K 100 + BLRV2K 80;
BLDP2 100 + BLPS 80; NRDP2 100 + RPS 80;
CSD2 100; SMSD2 100 + SMPS 80; ASDP3 100;
SDZ3 100; BSD2 100; NRDP2 100;
BSDPS 100 x 80; PDOP2 100 + PPS 80;
PDOP2 100; CRV1 100 + CPS 80;
CRV1 100 + CRV1 80; CSDL2 100;
CRV2 100 + CPS 80; CRV2 100 + CRV2 80;
MSD2 100; MSDPS 100 x 80;

Gigant Pro 110 x 80

SDOP 110 + PSS 80; ASDP3 110 + APSS 80;
BLRV2K 110 + BLRV2K 80;
NRDP2 110 + RPS 80; PDOP2 110 + PPS 80;
NRDP2 110, BSD3 110;
BSDPS 110 x 80; PDOP2 110; CSD2 110;
CRV2 110 + CPS 80; CRV2 110 + CRV2 80; CSD2 110;
CSDL2 110; MSD2 110; MSDPS 110 x 80;

Gigant Pro 120 x 80

SDOP 120 + PSS 80; ASDP3 120 + APSS 80;
BLRV2K 120 + BLRV2K 80 ;
BLDP2 110 + BLPS 80; NRDP2 120 + RPS 80;
BLDP2 120 + BLPS 80; BLDP4 120 + BLPS 80;
NRDP4 120 + RPS 80; PDOP2 120 + PPS 80;
SMSD2 120 + SMPS 80; ASDP3 120; SDOP 120;
BSD3 120; BSDPS 120 x 80; PDOP2 120;
CSD2 120; CSDL2 120; CRV2 120 + CPS 80;
CRV2 120 + CRV2 80; MSD2 120; MSDPS 120 x 80;

Gigant Pro 120 x 90

SDOP 120 + PSS 90; ASDP3 120 + APSS 90;
BLRV2K 120 + BLRV2K 90 ;
BLDP2 120 + BLPS 90; BLDP4 120 + BLPS 90;
NRDP2 120 + RPS 90; PDOP2 120 + PPS 90;
NRDP4 120 + RPS 90; ASDP3 120; SDOP 120;
BSD3 120; BSDPS 120 x 90;
PDOP2 120; CSD2 120; CSDL2 120;
CRV2 120 + CPS 90; CRV2 120 + CRV2 90;
SMSD2 120 + SMPS 90; MSD2 120; MSDPS 120 x 90;

L - left hand product option
R - right hand product option.

Panel option:



The products are as standard delivered within 14 days.

Galaxy Pro Chrome shower trays come without supportive legs and the front covering panel. Base Galaxy Pro includes supportive legs (5 pcs) and is suitable for all types of Galaxy Pro Chrome shower trays.

Shower Trays Galaxy Pro

Cast shower trays with a slip-resistant surface



Increased safety while taking a shower thanks to a slip-resistant surface.

Slip-resistant surface

The slip-resistant surface finish increases safety while showering.

Extra flat design

Very durable shower trays made of cast marble with an extra flat design suited for modern shower enclosures.

Easy-access solution

Due to their thickness of 30 mm, these shower trays are ideal walk-in access achieved by embedding them into the floor.



Embedded into the floor

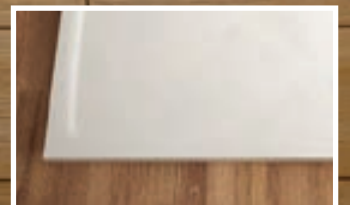

Glued directly onto the floor

Galaxy Pro Shower Trays

Elipso Pro 80, 90, 100



Galaxy Pro tray type	Price
Elipso Pro 80	✓
Elipso Pro 90	✓
Elipso Pro 100	✓
SET (panel + panelkit)	Price
Elipso Pro 80 SET	✓
Elipso Pro 90 SET	✓
Elipso Pro 100 SET	✓
BASE (supportive legs)	Price
Base Galaxy Pro	✓

Suitable for:

SKCP4 80, 90, 100; SKKP6 80, 90, 100; BLCPC4 80, 90, 100; NRKCP4 80, 90, 100; PSKK3 80, 90, 100; CSKK4 80, 90; SMSKK4 80, 90; BSKK3 80, 90, 100; BSKK4 80, 90, 100;

Perseus Pro 80, 90, 100



Galaxy Pro tray type	Price
Perseus Pro 80	✓
Perseus Pro 90	✓
Perseus Pro 100	✓
SET (panel + panelkit)	Price
Perseus Pro 80 SET	✓
Perseus Pro 90 SET	✓
Perseus Pro 100 SET	✓
BASE (supportive legs)	Price
Base Galaxy Pro	✓

Suitable for:

SRV2-S + SRV2-S 80, 90, 100; ASRV3 + ASRV3 80, 90; BLRV2 80, 90; BLRV2K + BLRV2K 80, 90, 100; NRKR2 80, 90, 100; CRV1 80, 90, 100; CRV2 80, 90, 100; SMSRV4 80, 90; BSRV4 80, 90, 100; BSDPS 80, 90, 100;

and shower areas with shower doors
ASDP3 80, 90, 100; SDZ3 80, 90, 100; SDOP 80, 90, 100; BLDP2 100; PDOP1 80, 90; PDOP2 100; CSD1 80, 90; CSD2 100; CSDL2 90, 100; SMSD2 90, 100; BSD2 80, 90, 100;

Gigant Pro 100 x 80, 110 x 80, 120 x 80, 120 x 90



Galaxy Pro tray type	Price
Gigant Pro 100 x 80	✓
Gigant Pro 110 x 80	✓
Gigant Pro 120 x 80	✓
Gigant Pro 120 x 90	✓
SET (panel + panelkit)	Price
Gigant Pro 100 x 80 SET L/R	✓
Gigant Pro 110 x 80 SET L/R	✓
Gigant Pro 120 x 80 SET L/R	✓
Gigant Pro 120 x 90 SET L/R	✓
BASE (supportive legs)	Price
Base Galaxy Pro	✓

Suitable for:

Gigant Pro 100 x 80

SRV2-S 100 + SRV2-S 80; SDZ3 100 + PSS 80; SDOP 100 + PSS 80; ASDP3 100 + APSS 80; BLRV2K 100 + BLRV2K 80; BLDP2 100 + BLPS 80; NRDP2 100 + RPS 80; CSD2 100; SMSD2 100 + SMPS 80; ASDP3 100; SDZ3 100; BSD2 100; NRDP2 100; BSDPS 100 x 80; PDOP2 100 + PPS 80; PDOP2 100; CRV1 100 + CPS 80; CRV1 100 + CRV1 80; CSDL2 100; CRV2 100 + CPS 80; CRV2 100 + CRV2 80;

Gigant Pro 110 x 80

ASDP3 110 + APSS 80; SDOP 110 + PSS 80; BLRV2K 110 + BLRV2K 80; NRDP2 110 + RPS 80; PDOP2 110 + PPS 80; NRDP2 110; BSD3 110; BSDPS 110 x 80; PDOP2 110; CSD2 110; CRV2 110 + CPS 80; CRV2 110 + CRV2 80; CSD2 110; CSDL2 110;

Gigant Pro 120 x 80

SDOP 120 + PSS 80; ASDP3 120 + APSS 80; BLRV2K 120 + BLRV2K 80; BLDP2 110 + BLPS 80; NRDP2 120 + RPS 80; BLDP2 120 + BLPS 80; BLDP4 120 + BLPS 80; NRDP4 120 + RPS 80; PDOP2 120 + PPS 80; SMSD2 120 + SMPS 80; ASDP3 120; SDOP 120; BSD3 120; BSDPS 120 x 80; PDOP2 120; CSD2 120; CSDL2 120; CRV2 120 + CPS 80; CRV2 120 + CRV2 80;

Gigant Pro 120 x 90

SDOP 120 + PSS 90; ASDP3 120 + APSS 90; BLRV2K 120 + BLRV2K 90; BLDP2 120 + BLPS 90; BLDP4 120 + BLPS 90; NRDP2 120 + RPS 90; PDOP2 120 + PPS 90; NRDP4 120 + RPS 90; ASDP3 120; SDOP 120; BSD3 120; BSDPS 120 x 90; PDOP2 120; CSD2 120; CSDL2 120; CRV2 120 + CPS 90; CRV2 120 + CRV2 90; SMSD2 120 + SMPS 90;

L - left hand product option
R - right hand product option.

Panel options:



The products are as standard delivered within 14 days.

Galaxy Pro shower trays come without supportive legs and the front covering panel. Base Galaxy Pro includes supportive legs (5 pcs) and is suitable for all types of Galaxy Pro shower trays.

Shower Trays Galaxy Pro Flat

Cast shower trays suited for modern bathrooms



Easy maintenance thanks to the smooth bottom of the shower tray.

Smooth bottom

Smooth bottom makes maintenance of the tray easier.

Extra flat design

Very durable shower trays made of cast marble with an extra flat design suited for modern shower enclosures.

Easy-access solution

Due to their thickness of 30 mm, these shower trays are ideal for walk-in access achieved by embedding them into the floor.



Embedded into the floor

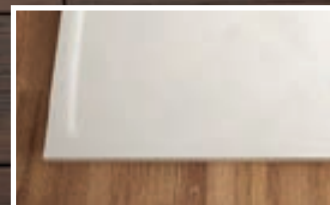

Glued directly onto the floor

Galaxy Pro Flat Shower Trays

Elipso Pro Flat 90



Galaxy Pro Flat tray type	Price
Elipso Pro 90 Flat	✓
SET (panel + panelkit)	Price
Elipso Pro 90 SET	✓
BASE (supportive legs)	Price
Base Galaxy Pro	✓

Suitable for:

SKCP4 90; SKKP6 90; BLCP4 90; NRKCP4 90; PSKK3 90; CSKK4 90; SMSKK4 90; BSKK3 -90; BSKK4 90;

Perseus Pro Flat 90



Galaxy Pro Flat tray type	Price
Perseus Pro 90 Flat	✓
SET (panel + panelkit)	Price
Perseus Pro 90 SET	✓
BASE (supportive legs)	Price
Base Galaxy Pro	✓

Suitable for:

SVR2-S + SRV2-S 90; ASRV3 + ASRV3 90; BLRV2 90; BLRV2 90; BLRV2K + BLRV2K 90; NRKRV2 90; CRV2 90; SMSRV4 90; BSRV4 90; BSDPS 90; CRV1 90;

and shower spaces with shower doors ASDP3 90; SDZ3 90; SDOP 90; PDOP1 90; CSD1 90; CSDL2 90; SMSD2 90; BSD2 90; BLDP2 90;

Gigant Pro Flat 100x80,120x90



Galaxy Pro Flat tray type	Price
Gigant Pro 100 X 80 Flat	✓
Gigant Pro 120 X 90 Flat	✓
SET (panel + panelkit)	Price
Gigant Pro 100 X 80 SET L/R	✓
Gigant Pro 120 X 90 SET L/R	✓
BASE (supportive legs)	Price
Base Galaxy Pro	✓

Suitable for:

bricked space (a niche) or shower area created by combining a shower door and fixed wall shower doors: ASDP3 SDZ3 BLDP2 BLDP4 BSDPS BLRV2K + BLRV2K NRDP2 NRDP4 PDOP1 PDOP2 CSD1 CSD2 CSDL2 CRV2 CRV1 SMSD2 BSD2

fixed walls: PSS APSS BLPS RPS CPS SMPS

L - left hand product option
R - right hand product option.

Panel options:



To install a shower tray, we recommend using the universal mounting kit that will make the sealing of the tray easier.

▶ see p. 127



The products are as standard delivered within 14 days.

Galaxy Pro Flat shower trays come without supportive legs and the front covering panel. Base Galaxy Pro includes supportive legs (5 pcs) and it is suitable for all types of Galaxy Pro Flat shower trays.

Deep seating tray **MINI-BATH**

When a classic bath doesn't fit



Shower tray protection against
bacteria and yeasts.

Is a bath too big for your bathroom?

Do your kids love having baths more than anything? Sabina deep seating mini-bath is designed for small bathrooms, where it will provide a possibility of having a bath or comfortable sitting while showering.

With its depth of 27 cm, it combines the benefits of a bath and a shower enclosure.

Antibac

Special protection method against growth and multiplication of bacteria and yeasts.

Sabina 80, 90

LA type
designed for underpinning or embedding



LA

LA type + BASE
an LA shower tray with supportive legs designed for underpinning



LA + BASE

LA type + BASE + SET
an LA shower tray with supportive legs and a front covering panel



LA + BASE + SET

Mini-bath type	Price
Sabina 80 LA	✓
Sabina 90 LA	✓
Support (base)	Price
Sabina 80 BASE	✓
Sabina 90 BASE	✓
Panel	Price
Sabina 80 SET	✓
Sabina 90 SET	✓
Panelkit	Price
Panelkit Sabina 80, 90	✓

It is necessary to use the panelkit to mount the panel.

Suitable for:

lowered shower enclosures SKCP4 Sabina 80, 90 and BLCP4 Sabina 80, 90

The Sabina mini-bath is made using traditional technology, i.e. by reinforcing the acrylic shell with an epoxy resin and glass fibres.

The Sabina bath can be underpinned and encased, or you can stand it on the ground on its legs and attach a front covering panel. In any case, we recommend using the original support (legs), which can even support the seating part of the bath.

You can find the waste trap for the Sabina bath on page 125.



Shower Trays Galaxy

Extra Flat and Simply Beautiful



Shower tray protection against bacteria and yeasts.

Flat modern design

Extra flat acrylic shower tray with a depth of only 5 cm will enhance the appearance of any shower enclosure.

Antibac

Special protection method against growth and multiplication of bacteria and yeasts.

Galaxy Shower Trays

Elipso 80, 90, 100

LA type designed for installing on a base, or for embedding



EX type a self-supporting tray without a front covering panel intended for encasing



PAN type a self-supporting tray with the front covering panel included in the price

PP+SET L a self-supporting tray + front and side panels (panels not included)



Perseus 80, 90, 100

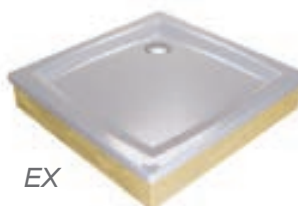
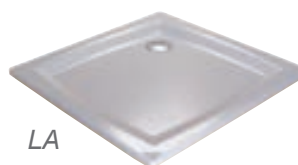

Galaxy tray type	Price
Elipso 80 LA	✓
Elipso 80 PAN	✓
Elipso 80 EX	✓
Elipso 90 LA	✓
Elipso 90 PAN	✓
Elipso 90 EX	✓
Elipso 100 LA	✓
Elipso 100 PAN	✓
Elipso 100 EX	✓
Support (base)	Price
Universal Base 600 (for trays 80)	✓
Universal Base 650 (for trays 90)	✓
Universal Base 750 (for trays 100)	✓

Suitable for:

SKCP4 80, 90, 100; SKKP6 80, 90, 100; BLCPC4 80, 90; NRKCP4 80, 90, 100; PSKK3 80, 90, 100; CSKK4 80, 90; SMSKK4 80, 90; BSKK3 - 80, 90, 100; BSKK4 80, 90, 100;

Galaxy tray type	Price
Perseus 80 LA	✓
Perseus 80 PP	✓
Perseus 80 EX	✓
Perseus 90 LA	✓
Perseus 90 PP	✓
Perseus 90 EX	✓
Perseus 100 LA	✓
Perseus 100 PP	✓
Perseus 100 EX	✓
Set (panel + panelkit)	Price
Perseus 80 SET N	✓
Perseus 80 SET L	✓
Perseus 90 SET N	✓
Perseus 90 SET L	✓
Perseus 100 SET N	✓
Perseus 100 SET L	✓
Support (base)	Price
Universal Base 600 (for trays 80)	✓
Universal Base 650 (for trays 90)	✓
Universal Base 750 (for trays 100)	✓

Suitable for:

SRV2-S + SRV2-S 80, 90, 100; ASRV3 + ASRV3 80, 90; BLRV2K + BLRV2K 80, 90; NRKR2 80, 90, 100; CRV1 80, 90, 100; CRV2 80, 90, 100; SMSRV4 80, 90; BSRV4 80, 90, 100; BSDPS 80, 90, 100;

and shower areas with shower doors
ASDP3 80, 90, 100; SDZ3 80, 90, 100; SDOP 80, 90, 100; BLDP2 100; PDOP1 80, 90; PDOP2 100; CSD1 80, 90; CSD2 100; CSDL2 90, 100; SMSD2 90, 100; BSD2 80, 90, 100;



To install a shower tray, we recommend using the universal mounting kit that will make the sealing of the tray easier.

► see p. 127

The products are as standard delivered within 14 days.

Shower Trays **Kaskada**

Trays for everyone - reliable and good value products



Shower tray protection against bacteria and yeasts.

Deeper shower tray

Depth of the shower tray is approximately 9 cm for comfortable showering. Tray bottom features a characteristic cascade surface.

Versatile

These acrylic shower trays can be installed on a base or directly onto the floor, or embedded into the floor.

The EX type is suited for encasing.

Antibac

Special protection method against growth and multiplication of some species of bacteria and yeasts.

Kaskada Shower Trays

Ronda 80, 90

LA type designed for installing on a base, or for embedding



LA

Angela 80, 90

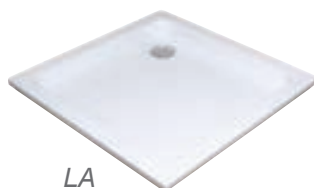

LA

Aneta 75 x 90

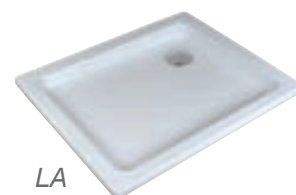

LA

EX type a self-supporting tray without a front covering panel intended for encasing



EX

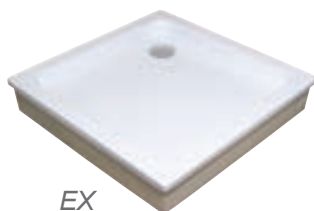

EX



EX

PU type a self-supporting tray with an integrated front covering panel



PU

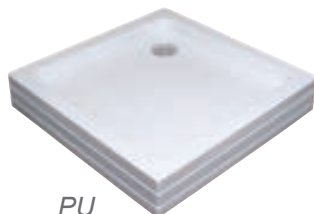

PU

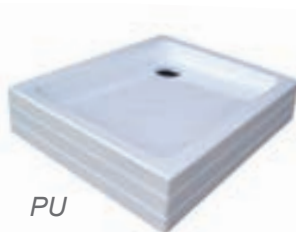

PU

Kaskada tray type	Price
Ronda 80 LA	✓
Ronda 80 PU	✓
Ronda 80 EX	✓
Ronda 90 LA	✓
Ronda 90 PU	✓
Ronda 90 EX	✓
Support (base)	Price
Universal Base 600 (for trays 80)	✓
Universal Base 650 (for trays 90)	✓

Suitable for:

SKCP4 80, 90; SKKP6 80, 90; BLCP4 80, 90; PSKK3 80, 90; NRKCP4 80, 90; CSKK4 80, 90; SMSKK4-80, 90; BSKK3 -80, 90; BSKK4-80, 90

Kaskada tray type	Price
Angela 80 LA	✓
Angela 80 PU	✓
Angela 80 EX	✓
Angela 90 LA	✓
Angela 90 PU	✓
Angela 90 EX	✓
Support (base)	Price
Universal Base 600 (for trays 80)	✓
Universal Base 650 (for trays 90)	✓

Suitable for:

SRV2-S + SRV2-S 80, 90; ASRV3 + ASRV3 80, 90; BLRV2K + BLRV2K 80, 90; BLRV2 80, 90; NRKRV2 80, 90; CRV1 80, 90; CRV2 80, 90; BSDPS-80,90 and shower spaces with shower doors ASDP3 80, 90; SDZ3 80, 90; SDOP 80, 90; PDOP1 80, 90; CSD1 80, 90; CSDL2 90; SMSD2-90; BSD2-80, 90

Kaskada tray type	Price
Aneta 75 x 90 LA	✓
Aneta 75 x 90 PU	✓
Aneta 75 x 90 EX	✓
Support (base)	Price
Universal Base 650	✓

Suitable for:

shower areas with shower doors ASRV3 75 + ASRV3 90; ASDP3 90; SDZ3 90, SDOP 90; SRV2-S 75 + SRV2-S 90; PDOP1 90

To install a shower tray, we recommend to use the universal mounting kit that will make the sealing and mounting of the tray easier. See p. 127



Accessories for Shower Trays



Waste Traps

High flow

The waste trap diameter is 90 mm, ensuring an outflow of at least 30 litres of water per minute. Therefore, they are suitable for shower enclosures with a hydro massage panel.

Easy to clean

All shower tray traps can be cleaned from the above after removing the cap which makes them suitable for "fixed" installed shower trays.

Options

Differences between the traps consist in different kinds of material used for the trap cover and its shape.

Accessories for Shower Trays

Basic



A shower tray trap with a stainless steel cover.



Standard



A shower tray trap with a metal plated plastic cover.



Professional



A shower tray trap with a metal cover.



Sabina Waste Trap



Intended for the Sabina mini-baths that have 52 mm Ø waste trap and overflow openings. Water outflow is controlled using the ClickClack system (the trap is closed by pressing the cover and opened by another pressing).



Waste Trap Adaptor 40/50



Reduces dimension differences between the drain pipe and waste trap.

RAVAK Professional sanitary silicone - 310 ml

RAVAK has tested and tried many silicones developed by major traditional manufacturers. One of the main conditions was the quality and durability of the sealed connections, as well as the ability to fix various materials used for shower enclosures, shower trays and baths together. Tests proved that it is almost impossible to choose a silicone that can adhere to glass, as well as to acrylic (PMMA), extruded polystyrene, aluminium, enamel, and many kinds of facing materials and tiles.

Therefore, RAVAK decided to co-operate with other manufacturers on developing their own silicone formula to fulfil all the above requirements.

RAVAK Professional sanitary silicone comes in two colours - white and clear (transparent).

Using the RAVAK Professional silicone is essential for sealing your shower enclosure, bath or shower tray properly.

It takes almost the whole 310ml tube of silicone to fully fix and seal a shower tray.



Cover strips



Cover strips

Used to seal the gap between the wall and the shower tray. They optimally cover and seal the gap, so cleaning is much easier than in the case of an unevenly applied sealant which spoils the appearance of the whole work when dirt settles on it. Cover strips can be purchased in the lengths of 1100 and 2000 mm and types 6, 10 or 11 mm. They are suitable for all types of shower trays.

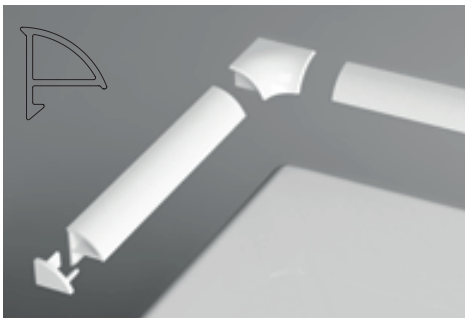

Cover strip 6

- seals gaps up to 6 mm
- it can be supplied with a set containing 2 cover strip end pieces (L,R) and 2 corner connectors

Cover strips	Price
Cover strip 6/1100 white	✓
Cover strip 6/2000 white	✓
Set for the cover strip 6	✓

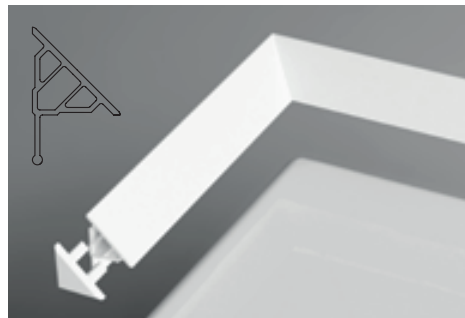

Cover strip 10

- seals a gap up to 10 mm
- can be complemented with an end piece
- cut at 45 degrees to create a corner

Cover strips	Price
Cover strip 10/1100 white	✓
Cover strip 10/2000 white	✓
Cover strip end piece 10 - white	✓

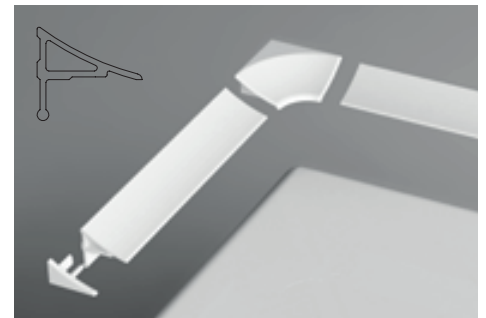

Cover strip 11

- seals gaps up to 11 mm
- it can be supplied with a set containing 2 cover strip end pieces (L/R) and 2 corner connectors

Cover strips	Price
Cover strip 11/1100 white	✓
Cover strip 11/2000 white	✓
Set for the cover strip 11	✓

The products are as standard delivered within 14 days.

Accessories for Shower Trays

Recommended way of sealing a shower tray

Badly covered gap between the tray and the wall which will boost the formation of mould and mildew is really unnecessary. If you insert a cover strip into the joint between the shower tray and the wall, your work will become really professional.

Cover strip

RAVAK sanitary silicone

Self-adhesive strip

Shower Tray



Universal Mounting Kit

The Universal Mounting Kit is used for perfect sealing of a shower tray when installed into an already finished shower enclosure. This way the shower tray can be perfectly connected to the bathroom walls – perfectly in both appearance and function.

Universal Mounting Kit includes:

RAVAK Professional sanitary silicone, white, 310 ml
Self-adhesive strip 2200 mm
2 cover strips 6/1200 mm
2 corner connecting pieces for cover strips



Universal Base

Universal Base is suitable for all LA type shower trays (except for Sabina) and helps you to install the tray in perfect level. A shower tray that has been set and levelled on this support can easily be underpinned and tiled.

The Universal Base consists of two metal bearers (600, 650 or 750 mm long – according to dimensions of the tray) and four adjustable legs.



Base Galaxy Pro

The Galaxy Pro, Galaxy Pro Flat and Galaxy Pro Chrome cast trays can be installed directly into the floor without the need for the supportive legs.

If you want to install the tray onto the base, we recommend you to use the Galaxy Pro Base set containing 5 legs. The floor should be tiled before the work.



Base (supportive legs) for shower trays	Price
Universal Base 600 under the trays LA 80 cm + Aneta 75 x 90 LA	✓
Universal Base 650 under the trays LA 90 cm	✓
Universal Base 750 under the trays LA 100 cm	✓
Base Galaxy Pro under the trays Galaxy Pro	✓

The products are as standard delivered within 14 days.

Shower Channels and Floor Drains

*Enhance the beauty
of your ceramic tiles*

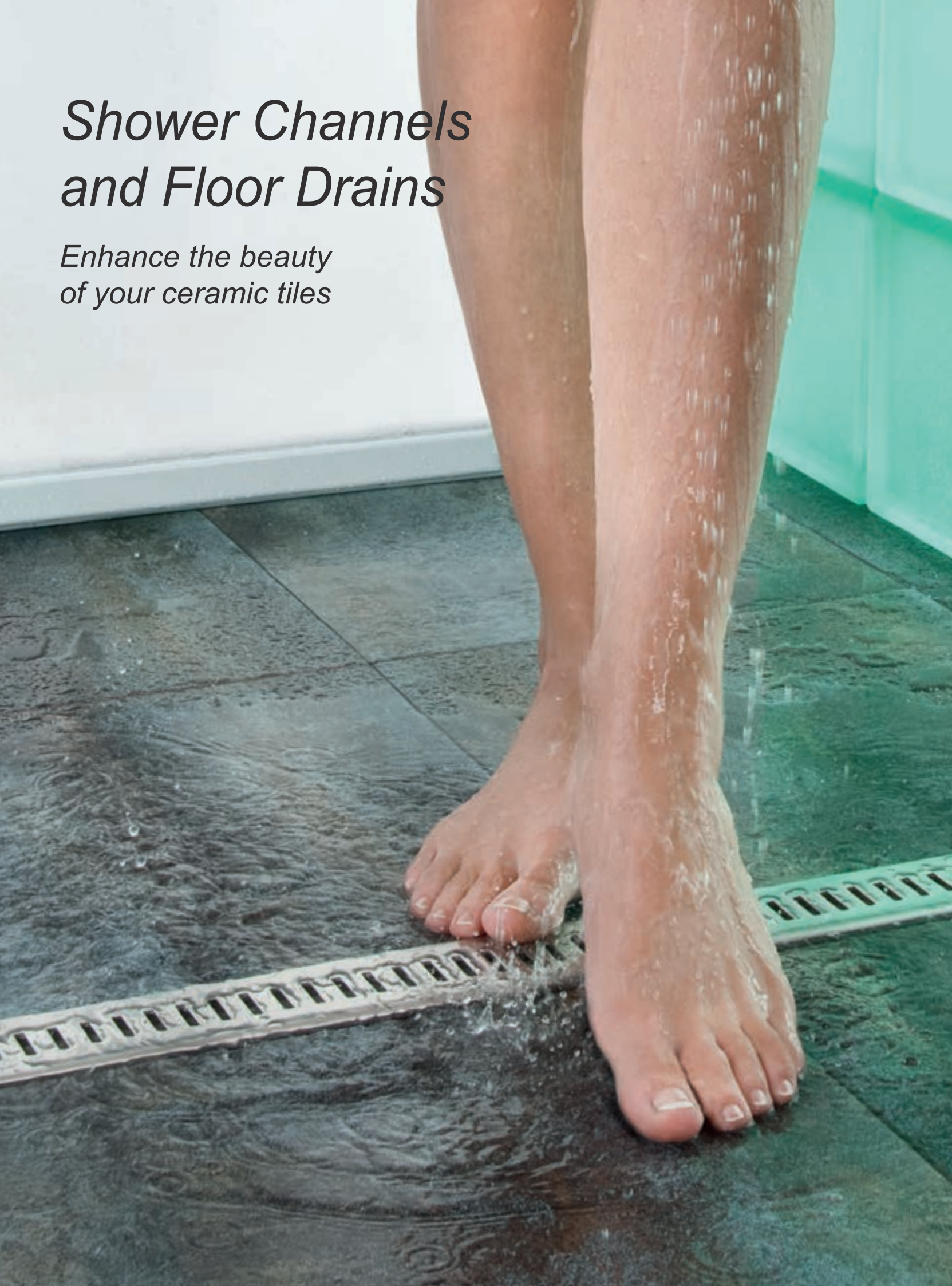

Shower Channels

Floor 850, 950, 1050



Price from: **11 590,-**

Floor stainless steel shower channel

- Both the channel and the grid are made of high-quality stainless steel with a special finish to prevent soiling. The channel is adjusted for tile installation.
- Perfect and easy cleaning of the whole channel and waste trap.
- The waste trap flow rate 60 l/min guarantees safe drainage of any inflowing water.
- Double anti-odour seal
- Height of the double anti-odour seal 50 mm
- Very easy, fast and precise installation



Type	Construction height (mm)	Minimum shower enclosure width (mm)	Price
OZ Floor 850	110	900	✓
OZ Floor 950	110	1000	✓
OZ Floor 1 050	110	1100	✓

Suitable to walk barefoot on, provide an ideal barrier-free solution - quick and easy installation

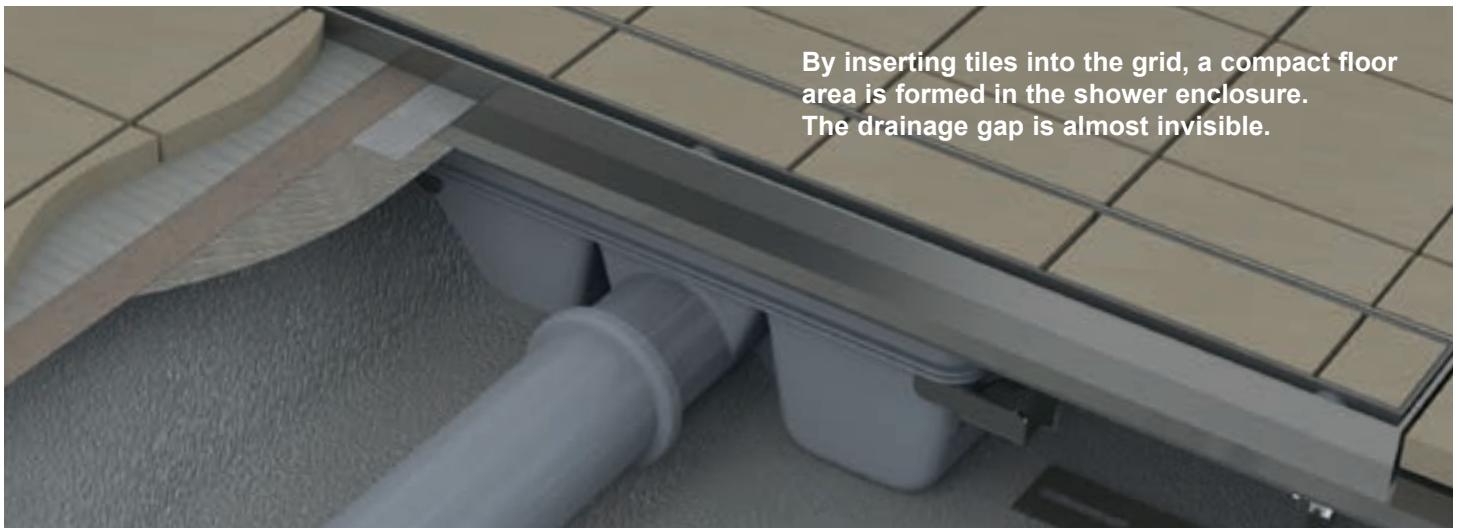

By inserting tiles into the grid, a compact floor area is formed in the shower enclosure. The drainage gap is almost invisible.

The products are as standard delivered within 14 days.

Shower Channels and Floor Drains

Runway 300, 850, 950, 1050



Chrome 300, 850, 950, 1050

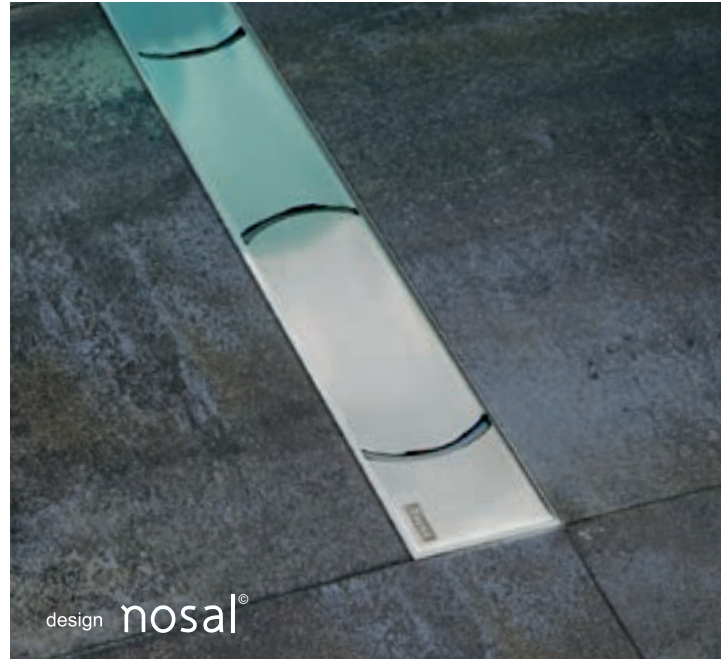

Runway stainless steel shower channel



- Both the channel and the grid are made of high-quality stainless steel with a special finish to prevent soiling.
- Perfect and easy cleaning of the whole channel and waste trap.
- The waste trap flow rate 60 l/min guarantees safe drainage of any inflowing water.
- Double anti-odour seal
- Height of the double anti-odour seal 50 mm
- Very easy, fast and precise installation

Chrome stainless steel shower channel



- RAVAK design within the Chrome Concept
- Both the channel and the grid are made of high-quality stainless steel with a special finish to prevent soiling.
- Perfect and easy cleaning of the whole channel and waste trap.
- The waste trap flow rate 60 l/min guarantees safe drainage of any inflowing water.
- Double anti-odour seal
- Height of the double anti-odour seal 50 mm
- Very easy, fast and precise installation

Type	Construction height (mm)	Minimum shower enclosure width (mm)	Price
OZ Runway 300	100	-	✓
OZ Runway 850	100	900	✓
OZ Runway 950	100	1000	✓
OZ Runway 1 050	100	1100	✓

Type	Construction height (mm)	Minimum shower enclosure width (mm)	Price
OZ Chrome 300	100	-	✓
OZ Chrome 850	100	900	✓
OZ Chrome 950	100	1000	✓
OZ Chrome 1 050	100	1100	✓

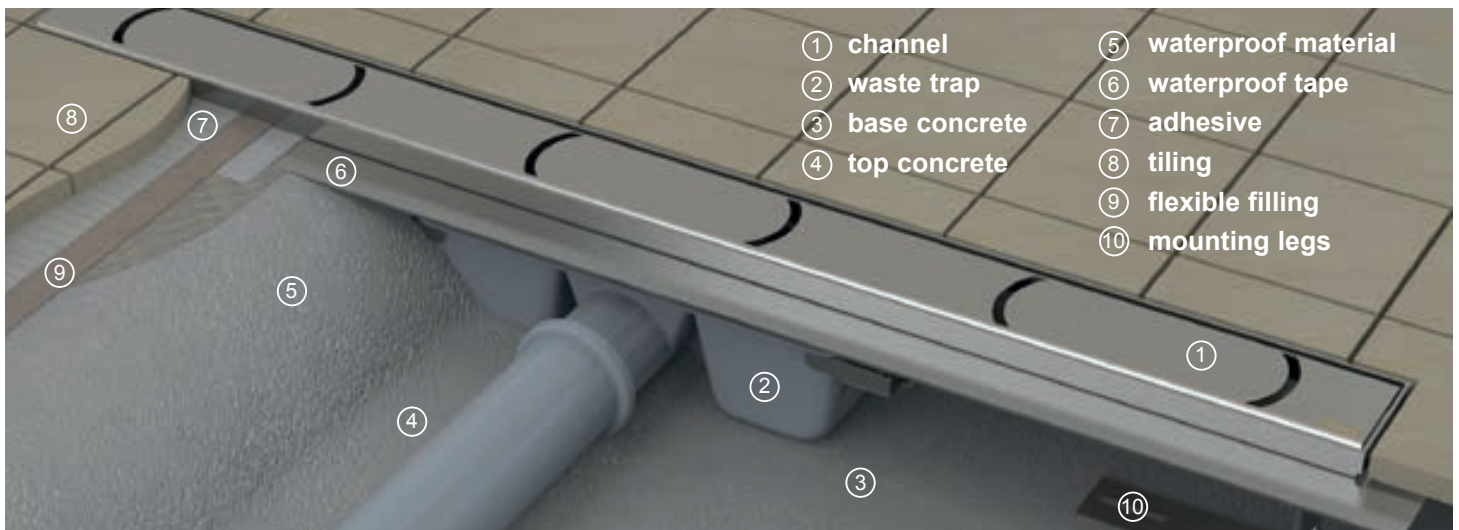

- ① channel
- ② waste trap
- ③ base concrete
- ④ top concrete
- ⑤ waterproof material
- ⑥ waterproof tape
- ⑦ adhesive
- ⑧ tiling
- ⑨ flexible filling
- ⑩ mounting legs

The products are as standard delivered within 14 days.

Shower Channel

Zebra 750, 850



Zebra Plastic shower channel with stainless steel grid

- thanks to low construction height it is suitable for reconstructions
- easy to clean down to the drain pipe
- flow rate 30 l/min with catchment drain
- combined anti-odour seal with the height of water column of 28 mm
- low construction height - 75 mm including tiles
- increased resistance of plastic against chemicals



Type	Construction height (mm)	Minimum shower enclosure width (mm)	Price
OZP Zebra 750	75	800	✓
OZP Zebra 850	75	900	✓

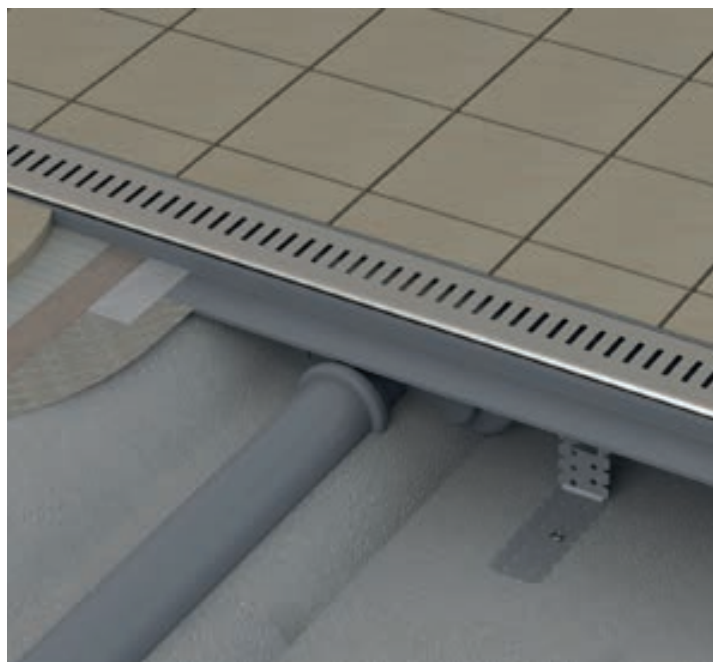

Floor Drain

SN501 105x105/50



SN501 Plastic drain with stainless steel grid

- suitable for shower enclosures, bathrooms, and utility areas
- the grid is made of high-quality stainless steel using a water-jet cutter
- flow rate 37 l/min
- combined anti-odour seal with the height of water column of 30 mm
- stainless steel flange and an isolation level 2 collet



Type	Minimum construction height (mm)	Price
Drain SN501 105x105/50	104	✓

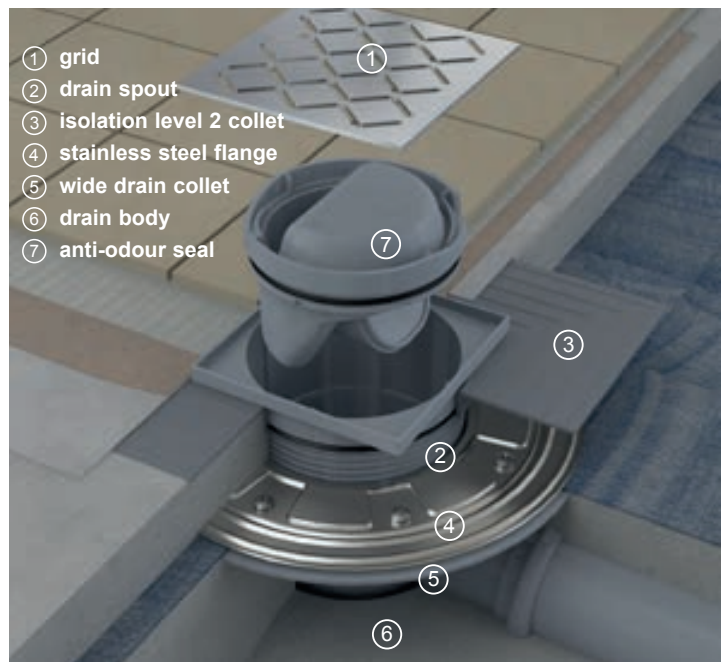

The products are as standard delivered within 14 days.

New



Safe bathroom

Walk without the worry of slipping

The SafeStep self-adhesive strips or squares offer a simple way of securing your steps in the bathroom.



3M for RAVAK

Safe bathroom

Anti-slip strips on a shower tray

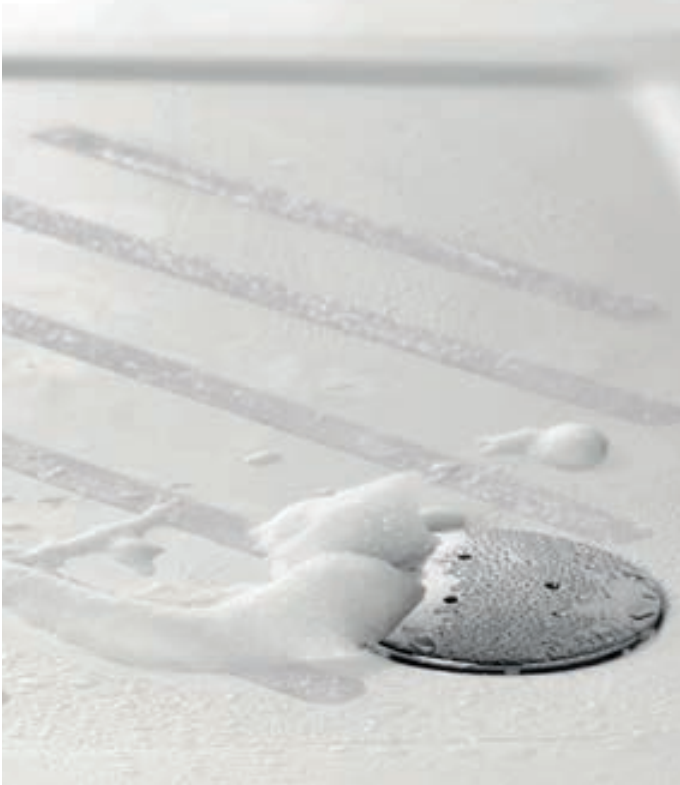

SafeStep / Strip

The safety adhesive strips / squares are made using the 3M very durable technology to withstand demanding operation. Their application is very simple and the two types combined with the discreet transparent design will suit any space. They perfectly adhere to all bathroom surfaces, wherever it is necessary to increase slip resistance of tiles, bathtubs and shower trays.

Anti-slip squares on floor tiles

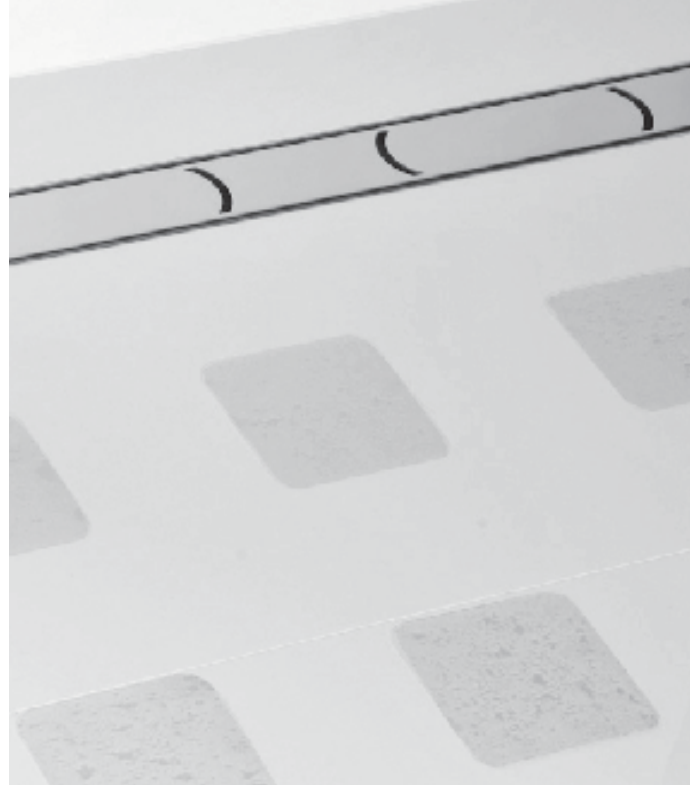

SafeStep / Square



Type	Dimensions (mm)	Design	Price
SafeStep / Strip 2 m	2000x25	Transparent	✓



Type	Dimensions (mm)	Design	Price
SafeStep / Square 4 pieces	100x100	Transparent	✓

Baths

Beautiful and comfortable

Each RAVAK bath is designed to combine aesthetic and functional requirements, each in a unique combination.





Baths

A free-standing, rectangular, or corner bath, with large shelf space, a bath into a small bathroom or a bath for two?

Freedom R 175 x 75 p. 140 - 141



New



Freedom O 169 x 80 p. 142 - 143



BathGallery 190x90 p. 144 - 145

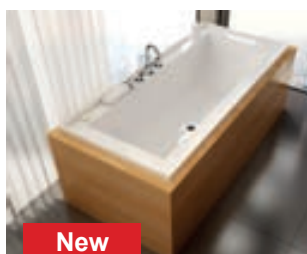

New



XXL 190x95 p. 146 - 147



Evolution 180 / 170 x 102 - 87 / 97 - 83 p. 148 - 149



You 185 / 175 x 85 p. 150 - 151



Magnolia 180 / 170 x 75 p. 152 - 153



Sonata 180x80, 170 x 75 p. 154 - 155

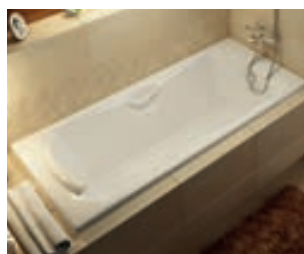

Campanula II 180x80, 170x75 p. 156 - 157

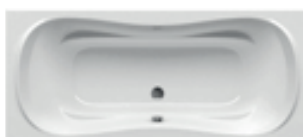

Chrome 170 x 75, 160 / 150 x 70 p. 158 - 159

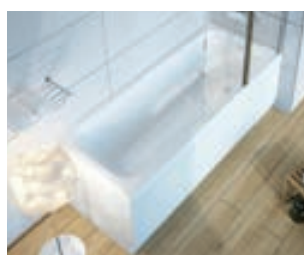

Classic 170 / 160 / 150 / 120 x 70 p. 160 - 161



Vanda II 170 / 160 / 150 x 70 p. 162 - 163



NewDay 150 x 150, 140 x 140 p. 164 - 165



Gentiana 150x150, 140x140 p. 166 - 167



LoveStory II 196 x 139 p. 168 - 169



10° 170 x 100, 160 x 95 p. 170 - 171

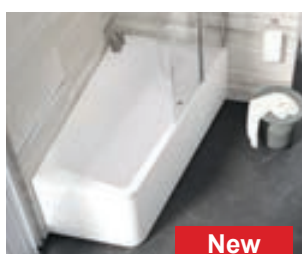

Rosa II 170 / 160 / 150x105 p. 172 - 173



Rosa 95 160 / 150 x 95 p. 174 - 175

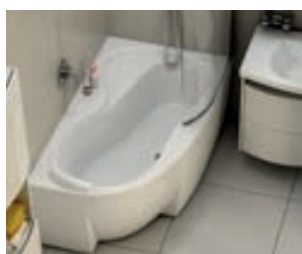

Rosa I 160 / 150 / 140x105 p. 176 - 177



Avocado 160 / 150x75 p. 178 - 179



BeHappy 170 / 160 / 150x75 p. 180 - 181



Asymmetric 170 x 110, 160 x 105, 150 x 100 p. 182 - 183



Why do baths differ?

Because their quality differs.

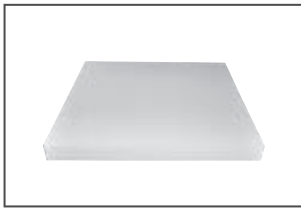

Acrylic plate (PMMA) No compromise on the material, we use the finest Lucite acrylic.



Acrylic moulding
We use technology to spot heating to guarantee optimum wall thickness baths in each location.



Moulding reinforcement
Hardening of the moulding by resin with the addition of fibreglass or polyurethane foam PU.



Finished bath
A finished bath of the highest possible quality on the market.

Why is the material used so important?

According to the method of the manufacturing of acrylic sheets, today the most common material for the manufacture of baths, we can distinguish two basic types of acrylic – extruded and cast acrylic. Chemically, they are both the same materials (polymethyl methacrylate - PMMA), but the different production methods cause significant differences in the utility qualities of this material. Extruded acrylic is produced by stretching, so its properties are preserved only in one direction. Sometimes, even thinner layer of extruded acrylic together with the ABS plastic plate is used. Baths made from this material exhibit the worst quality properties and after built into the bathroom they may eventually crack. Cast acrylic is poured into prepared moulds so the plate retains its physical behaviour in all directions. Cast acrylic is therefore a much better quality acrylic and it can guarantee that the product maintains its desired shape in the long term and that it doesn't sag or crack. That's why cast acrylic is more expensive than extruded.

These are the main reasons why cast acrylic is a number one choice for RAVAK which enables us to provide a ten-year warranty on baths.

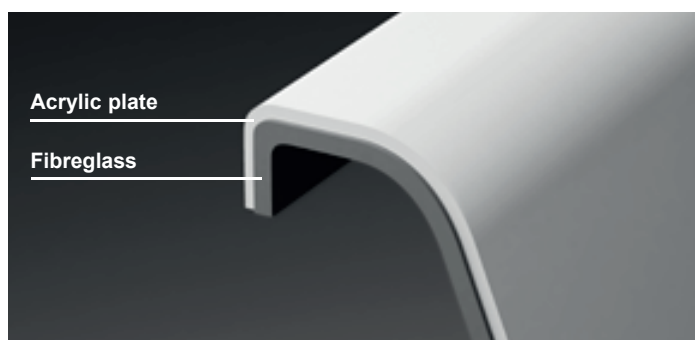
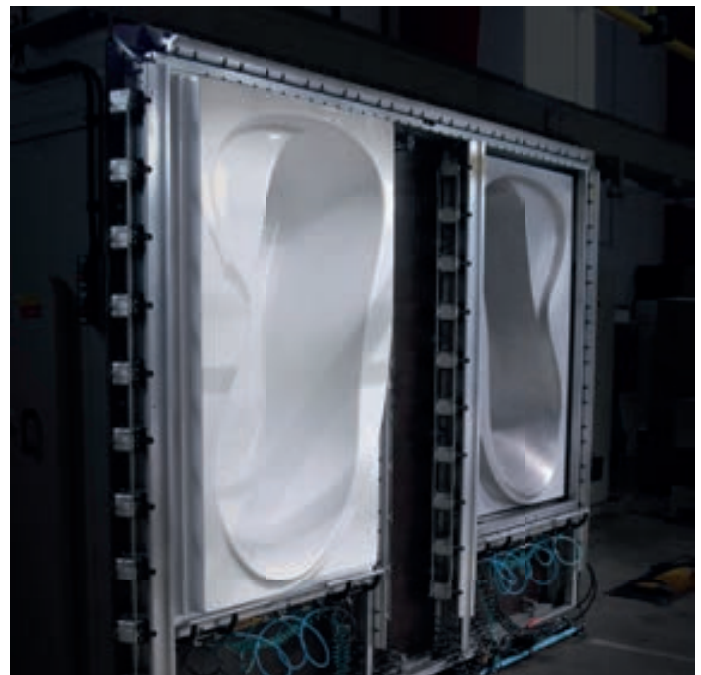

Fibreglass

The most commonly reinforcement is made of polyester resin filled with fibreglass.

When reinforcing with laminate, the acrylate moulding is sprayed with a mixture of resin and fibreglass. The ratio of these components and the amount of spray applicator is controlled by a computer for each individual bath. The product with the sprayed layer then hardens in the tempering tunnel where strict process technology rules apply as well. The advantage of the glass fibre reinforced laminate is that it makes a high strength and tough product which is available at an affordable price.

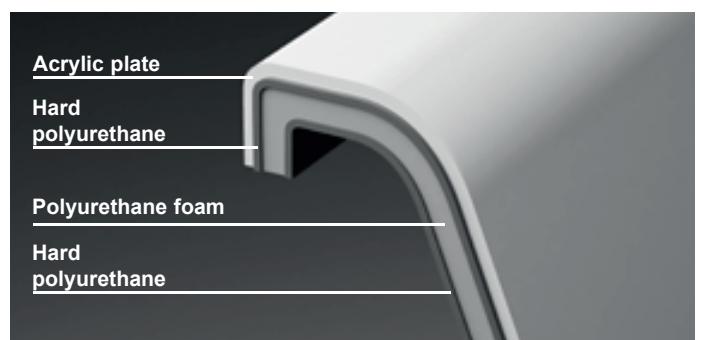

PU PLUS

PU Plus reinforcement is a unique technology of reinforcement made out of polyurethane foam which has been developed by RAVAK.

At a fully robotised facility, the acrylic moulding is sprayed with polyurethane foam in three layers: (hard-soft-hard, or solid-foam-solid). Thanks to the precise manufacturing process, the PU Plus product has unique rigidity, excellent heat and acoustic insulating properties. The baths are therefore extremely sturdy. They are also ideal for the installation of hydro massage systems. Recycling of the product is yet another advantage.

Why to choose a PU Plus reinforced bath?



A solid bath that won't budge

PU Plus baths are almost as rigid as enamelled steel.



Thermo insulating properties

PU Plus baths keep water warm much longer.



Fully automatic manufacture

High technologies from Kawasaki and Bayer unfailingly eliminate any imperfections caused by human error.



Ideal for hydro massage baths

PU Plus hydro massage baths offer much quieter operation. The water cools down more slowly, thus enhancing the comfort of a hydro massage bath.

Baths reinforced by the PU Plus technology:

Evolution [p. 148](#)



Magnolia [p. 152](#)



Sonata [p. 154](#)



NewDay [p. 164](#)



LoveStory II L/R [p. 168](#)



Rosa II L/R [p. 172](#)

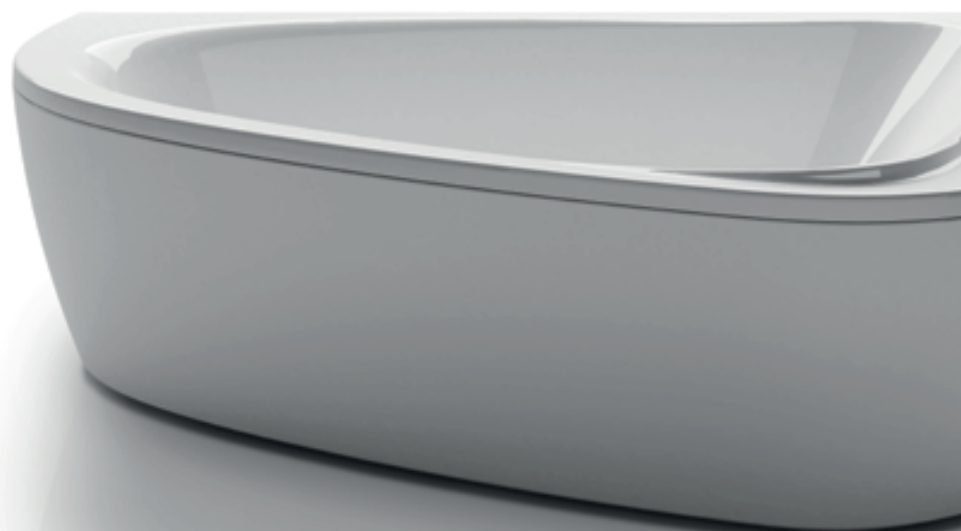

L - left hand product option. R - right hand product option.

Freedom R bath

Freedom is a state of mind



New

Freedom R bath



You establish the rules

Place the bath wherever you like and when bathing choose the side of the bathtub from which you have a better view. Do not limit yourself, relax.

Pragmatic style

Perpendicular angles, straight lines, and subtle appearance. Ethereally light bath for a simply modern bathroom.



Floor mounted water tap
FM 081.00



Product (type)	Price
BATH	
Freedom R 175x75	✓
WATER TAPS	
Floor mounted bath water taps FM 081.00	✓

All water pipes must be laid in the floor (both water drain and water supply pipes for the floor taps).
The Freedom R bath cannot be complemented by a bath screen.
Products are as standard delivered in 6 weeks.
Note: Freedom R bath and FM 081.00 water taps available from 04/2015.

Freedom O Bath

Freedom is a state of mind



Freedom O bath



You establish the rules

Place the bath wherever you like and when bathing choose the side of the bathtub from which you have a better view. Do not limit yourself, relax.

Natural

Graceful curved lines without sharp edges and corners. Friendly oval shape of the tub embraces you and gives you a natural feeling of relaxation.



Floor mounted water tap
FM 080.00



Product (type)	Price
BATH	
Freedom O 169x80	✓
WATER TAPS	
Floor mounted water taps 080.00	✓

All water pipes must be laid in the floor (both water drain and water supply pipes for the floor taps).
The Freedom O bath cannot be complemented by a bath screen.
Products are as standard delivered in 6 weeks.

Bath *BathGallery*

Minimalist harmony



New

design nosal[®]

BathGallery bath



Aesthetic composition

Each of the objects will find its ideal place on a wide shelf surface with a raised edge. Cleanliness of the tub's design and various options of the panelling always make it a balanced centrepiece.

Gallery of creativity

The bathtub made of cast marble is linked with a washbasin with interchangeable colour bottom and bathroom accessories in five colours. Possible combinations of colours of the washbasin and accessories give room for individual aesthetic expression.



Product (type)	Price
BATH	
BathGallery 190 90	✓



for the BathGallery bathroom set, see p. 30.

Note: The BathGallery bath cannot be complemented by a bath screen. Products are as standard delivered in 6 weeks.

XXL Bath

If you fancy an exceptionally large bath





Bath suited for both tall and short people

You cannot agree about an optimum size for all? The XXL bath suites either tall and short people who can prop their feet up against an integrated step

Maximum comfort

The generously shaped internal space of the bath allows a comfortable soak of the whole body from shoulders to knees and the ergonomically shaped armrests enhance relaxation of your arms.



XXL Headrest
Colour: white, grey
Price : 1 730,-

Product (type)	Price
BATH	
XXL 190x95	✓
SUPPORTS + PANELS + PANELKITS	
Support XXL	✓
Front panel XXL 190	✓
Covering panelkit	✓
Side panel XXL 95	✓



The big ones will fit, the short ones will not get drowned

Note: The XXL bath cannot be complemented by a bath screen.
The products are as standard delivered within 14 days.

Bath Evolution

Timeless and emotional

now with a length of 170 cm



Evolution Bath



Feeling of safety and tranquillity

Harmonious lines of the bath are inspired by the shapes of nature. No sharp edges or disturbing details

Design Nosal

An original design from the workshop of the Czech artist Kryštof Nosál.



Evolution Headrest
Colour: white, grey

Product (type)	Price
BATH	
Evolution 170x97	✓
Evolution 180x102	✓
Evolution PU Plus 180x102	✓ <input type="checkbox"/>
SUPPORTS + PANELS + PANELKITS	
Support Evolution	✓
Covering panel Evolution 170	✓
Covering panel Evolution 180	✓
Covering panelkit	✓
Side panel Evolution 83 L/R	✓
Side panel Evolution 87 L/R	✓

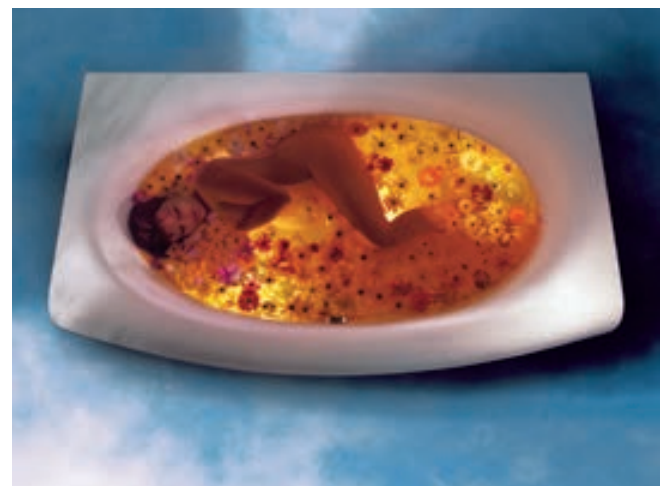

The Evolution bath can be equipped with the H₂O Color Chromotherapy. More at www.ravak.com

L - left hand product option. R - right hand product option.

PU Plus bath.

The Evolution bath cannot be complemented by a bath screen.

The products are as standard delivered within 14 days.

You Bath

Comfortable for every body type





How comfort gets done ...

Uniquely solved generous internal space of the bath, ergonomically shaped for perfect comfort of individual parts of the body - back, arms and legs.

Deeper than the other baths

Extra depth which allows you to submerge with shoulders to keep them warm even during a long bath.

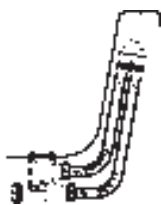

Hidden bath waste set for a bath without overflow



The bath waste set with overflow controlled by the Bowden cable or ClickClick. Length 800 mm.

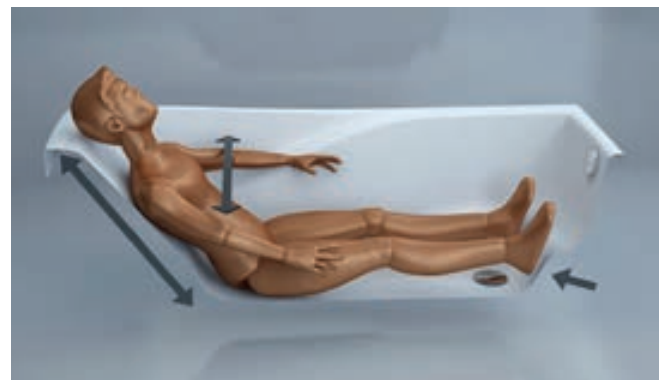

- It is the widest where you need it most - at the elbows
- allows you to lie or sit comfortably
- suitable both for tall and short figures - with the step you can use to rest your feet

Product (type)	Price
BATH	
You 175x85	✓
You 185x85	✓
You 175x85 without overflow	✓
You 185x85 without overflow	✓

SUPPORTS + PANELS + PANELKITS	
Support You	✓
Front panel You 175	✓
Front panel You 185	✓
Covering panelkit	✓
Side panel You L/R 85	✓

Note: The You bath cannot be complemented by a bath screen.
The products are as standard delivered within 14 days.



Bath Magnolia

*An elegant bath featuring surprisingly
generous internal space*

Magnolia Bath



Elegant lines

The curvaceous design of the front edge allows for the maximum utility of the internal space of the bath, enhancing the bathing experience.

More comfort

The outflow located in the centre predestines the bath for a couple.



Headrest Magnolia
Colour: white, grey

Product (type)	Price
BATH	
Magnolia 170x75	✓
Magnolia 180x75	✓
Magnolia PU Plus 170x75	✓ <input type="checkbox"/>
Magnolia PU Plus 180x75	✓ <input type="checkbox"/>
SUPPORTS + PANELS + PANELKITS	
Support Magnolia	✓
Front panel Magnolia 170	✓
Front panel Magnolia 180	✓
Covering panelkit	✓
Side panel Magnolia L/R	✓
Side panelkit	✓



L - left hand product option. R - right hand product option.

PU Plus bath.

Note: The Magnolia bath cannot be complemented by a bath screen.
The products are as standard delivered within 14 days.

Bath Sonata

*Distinctive Shape
of Internal Bathing Space*



Sonata Bath



Original lines

Distinctive sharp lines are honed to perfection by a headrest in matching design and fully integrated handles.

Both comfortable bathing and showering

Complemented by a bath screen or door, this bath also allows a comfortable showering.

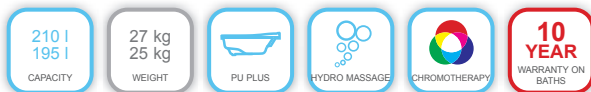

Sonata Headrest
Colour: white, grey



Sonata Handles
Colour: white, grey

The Sonata bath is also available in the PU Plus version with extra reinforcement.



Product (type)	Price
BATH	
Sonata 170x75	✓
Sonata 180x80	✓
Sonata PU Plus 170x75	✓ <input type="checkbox"/>
Sonata PU Plus 180x80	✓ <input type="checkbox"/>
SUPPORTS + PANELS + PANELKITS	
Support Sonata 170x75	✓
Support Sonata 180x80	✓
Front panel U 170	✓
Front panel U 180	✓
Covering panelkit	✓
Side panel U 75	✓
Side panel U 80	✓

The Sonata bath comes with pre-drilled holes for a headrest and handles.
Sonata without holes comes as a non-standard product with a six-week term of delivery.
 PU Plus bath.

Note: The Sonata bath can be complemented by the VS2, VS3, VS5, PVS1, BVS1, BVS2, CVS2 bath screens or the AVDP3 bath doors (see p. 192).
The products are as standard delivered within 14 days.

Bath

Campanula II

Romance in Modern Concept



Campanula II Bath



An elegant design

The harmonious shape of the internal space will captivate you.

More comfort

The outflow located in the centre allows a comfortable bathing for one or two people.



Campanula II Headrest
Colour: white, grey

Product (type)	Price
BATH	
Campanula II 170x75	✓
Campanula II 180x80	✓
SUPPORTS + PANELS + PANELKITS	
Support Campanula II 170x75	✓
Support Campanula II 180x80	✓
Front panel U 170	✓
Front panel U 180	✓
Covering panelkit	✓
Side panel U 75	✓
Side panel U 80	✓



The Campanula II bath with the PVS1 bath screen.

Note: The Campanula bath can be complemented by the PVS1, CVS2, BVS1, BVS2 bath screens or the AVDP3 bath doors (see p. 192).
The products are as standard delivered within 14 days.

Chrome Bath

Synergy of Design and Function



Chrome Bath



An oval-shaped bottom

The characteristic oval shape, comfortable sloping back and vertical sides predestine this bath for versatile use, for both bathing and showering.

Perfectly co-ordinated design unit - Chrome concept

You can match your bathroom into a single unit without having to laboriously collect each product separately. The bath can be completed with a shower enclosure, washbasin with furniture, water taps and shower tray or channel, toilet with bidet and bathroom accessories.



Handle*
Universal stainless steel

Product (type)	Price
BATH	
Chrome 150x70	✓
Chrome 160x70	✓
Chrome 170x75	✓
SUPPORTS + PANELS + PANELKITS	
Support Chrome	✓
Front panel Chrome 150	✓
Front panel Chrome 160	✓
Front panel Chrome 170	✓
Covering panelkit	✓
Side panel Chrome 70	✓
Side panel Chrome 75	✓



The bath is a part of Chrome concept, the widest on the market

*) The handle cannot be combined with a bath screen.
Note: The Chrome bath can be complemented by the CVS2 bath screen (see p. 194).
The products are as standard delivered within 14 days.

Bath Classic

Simplicity is Beauty

now with a length of 120 cm
for smaller space



Classic Bath

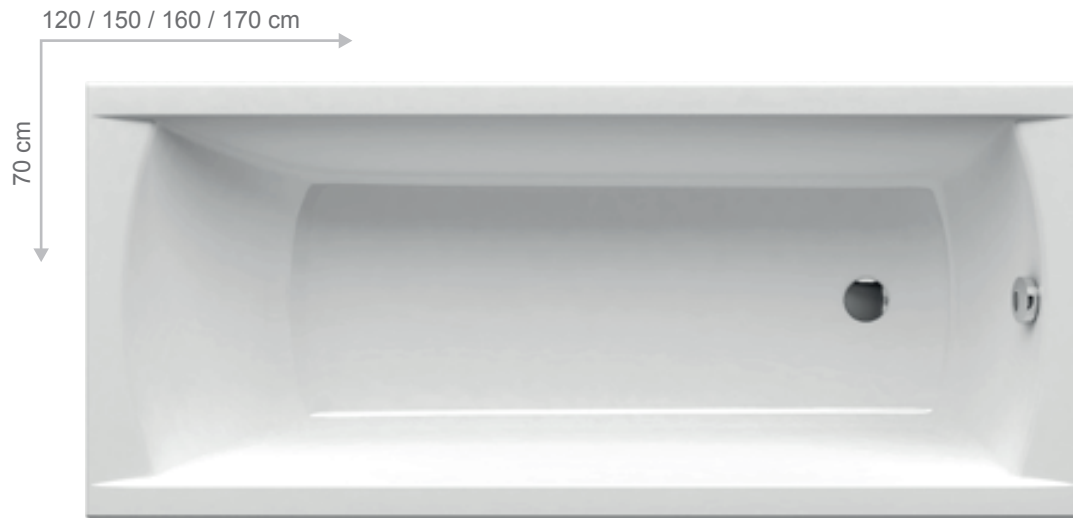

Although only 70 cm wide, this bath provides comfortable bathing
Safe flat bottom and a range of shower screens makes bathing and showering easier

Generous internal space

Subtle and elegant rims and sharper slope of the sides give the bath unusually large inner space for its small dimensions.

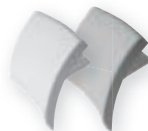

Classic Headrest
Colour: white, grey



Handle*
Universal stainless steel

Product (type)	Price
BATH	
Classic 120x70	✓
Classic 150x70	✓
Classic 160x70	✓
Classic 170x70	✓
SUPPORTS + PANELS + PANELKITS	
Support Classic	✓
Front panel U 150	✓
Front panel U 160	✓
Front panel U 170	✓
Covering panelkit	✓
Side panel U 70	✓

Note: The Classic bath can be complemented by the VS2, VS3, VS5, PVS1, BVS1, BVS2, CVS2 bath screens or the AVDP3 bath doors (see p. 192).

*) The handle cannot be combined with a bath screen. Headrest cannot be used for the 120 cm long bath. The products are as standard delivered within 14 days.



A mini-bath with a length of 120 cm can substitute a shower enclosure. Thanks to a standard depth of 42 cm, which is typical for all baths, it allows pleasant bathing e.g. for children, but when adding a bath screen it creates a perfectly sealed and large shower enclosure. Ideal solution for small bathrooms and niches.

Bath

Vanda II

A popular bath with agile lines



Vanda II Bath

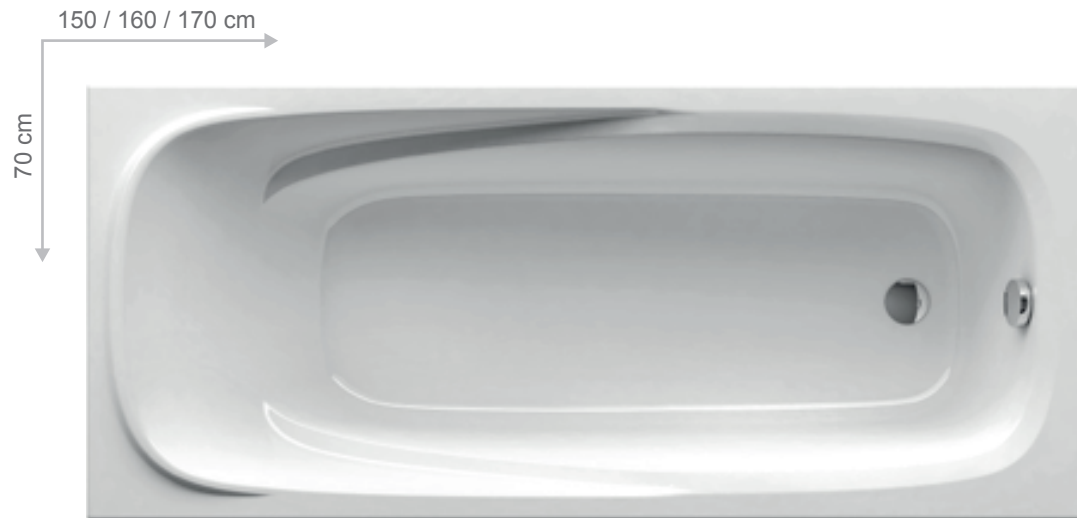

Several dimensional options

You can choose from three lengths which fit in every bathroom

Do you like to read in the bath?

Ergonomic armrests make getting out of the bath easier and safer and are perfect for comfortable reading in the bath.



Universal stainless steel handle*

Classic doesn't mean boring.



Product (type)	Price
BATH	
Vanda II 150x70	✓
Vanda II 160x70	✓
Vanda II 170x70	✓
SUPPORTS + PANELS + PANELKITS	
Support Vanda II	✓
Front panel U 150	✓
Front panel U 160	✓
Front panel U 170	✓
Covering panelkit	✓
Side panel U 70	✓

*) The handle cannot be combined with a bath screen.

Note: The Vanda II bath can be fitted with the VS2, VS3, VS5, PVS1, CVS2, BVS1, BVS2 bath screens or the AVDP3 bath doors (see p. 192). As standard, the products are delivered within 14 days.

Bath NewDay

*Modern and clean lines
for bathing of two*



NewDay Bath



Comfortable even for two

Enjoy sensual bathing with your partner thanks to the gentle slope of the back side of the bath and the central location of the waste outflow.

Shelf space

Wider bath rim and the seat above water level offer enough shelf space not only for the moments of relaxation.



NewDay Headrest
Colour: white, grey

Product (type)	Price
BATH	
NewDay 140	✓
NewDay 150	✓
NewDay 140 PU Plus	✓ <input type="checkbox"/>
NewDay 150 PU Plus	✓ <input type="checkbox"/>
SUPPORTS + PANELS + PANELKITS	
Support NewDay	✓
NewDay 140	✓
NewDay 150	✓
Panelkit	✓



The bath can be provided with the H₂O Color chromotherapy. More at www.ravak.com

L - left hand product option. R - right hand product option. PU Plus bath.

Note: The NewDay bath cannot be complemented by a bath screen.
The products are as standard delivered within 14 days.

Bath Gentiana

Comfort and space for two



Gentiana Bath



Perfect relaxation

A spacious and wide bath which guarantees the most comfortable bathing.

Handy accessories

Headrests, handles and a seat above the water level will provide maximum comfort when bathing and showering.



Gentiana Headrest
Colour: white, grey

Price :
1 530,-



Gentiana Handle
Colour: white, grey

Price :
1 530,-



The bath can be provided with the H₂O Color chromotherapy. More at www.ravak.com

Product (type)	Price
BATH	
Gentiana 140	✓
Gentiana 150	✓
SUPPORTS + PANELS + PANELKITS	
Support Gentiana	✓
Gentiana 140	✓
Gentiana 150	✓
Panelkit	✓

Note: The Gentiana bath cannot be complemented by a bath screen.
The products are as standard delivered within 14 days.

LoveStory II

Bath

Love for life



LoveStory II Bath



Loving bath

Enjoy your mutual closeness and comfort in the bath for two.

An innovated design

Story of love, safety, emotions and harmony materialised by Achim Storz, a famous designer of world-wide well-known brands.



LoveStory II Headrest
Colour: white, grey



Product (type)	Price
BATH	
LoveStory II L/R	✓
LoveStory II L/R PU Plus	✓ <input type="checkbox"/>
SUPPORTS + PANELS + PANELKITS	
Support LoveStory II	✓
LoveStory II L/R	✓
Panelkit	✓

L - left hand product option. R - right hand product option. PU Plus bath.

Note: The LoveStory II bath cannot be complemented by a bath screen.
The products are as standard delivered within 14 days.

Bath 10°

A new perspective



New

design nosal[®]

Bath 10°



Clever use of classic shape

Just a slight 10° rotation of a classic shape bath was enough to offer extra space which can be used as a shelf or seat.

Screen for a wide shower enclosure

Combined with a bath screen, the bath 10° offers plenty of room in the showering space.



Product (type)	Price
BATH	
10° 160x95 L/R	✓
10° 170x100 L/R	✓
SUPPORTS + PANELS + PANELKITS	
Support 10°	✓
Front panel 10° 160 L/R	✓
Front panel 10° 170 L/R	✓
Panelkit	✓

L - left hand product option, R - right hand product option.

Note: Bath 10° can be complemented by the 10CVS2 bath screen (see p. 197).
Bath 10° available from 03/2015.

The products are as standard delivered within 14 days.



Concept 10° is also suitable for smaller bathrooms.

Bath Rosa II

*A clever bath
in modern design*

*We gave asymmetric baths their name.
If you want quality, ask for RAVAK.*



Rosa II Bath



A spacious shower enclosure together with a comfortable bath

The showering part of the bath has a flat bottom and integrated seat, and in combination with a bath screen it provides an ideal showering space. The bathing part has a nicely gradual slope of the back portion inviting for comfortable bathing.

Refreshed design

Builds on the successful bath Rosa I which has been refreshed with modern lines by the internationally acclaimed designer Achim Storz

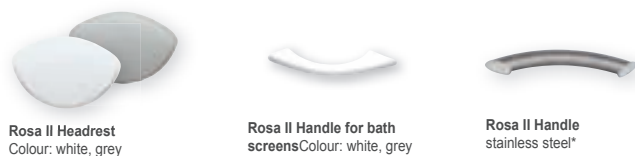

Rosa II Headrest
Colour: white, grey

Rosa II Handle for bath
screens Colour: white, grey

Rosa II Handle
stainless steel*

Product (type)	Price
BATH	
Rosa II L/R 150x105	✓
Rosa II L/R 160x105	✓
Rosa II L/R 170x105	✓
Rosa II L/R PU Plus 150x105	✓ <input type="checkbox"/>
Rosa II L/R PU Plus 160x105	✓ <input type="checkbox"/>
Rosa II L/R PU Plus 170x105	✓ <input type="checkbox"/>
SUPPORTS + PANELS + PANELKITS	
Support Rosa II	✓
Panel Rosa II 150 L/R	✓
Panel Rosa II 160 L/R	✓
Panel Rosa II 170 L/R	✓
Panelkit	✓



L - left hand product option. R - right hand product option.

PU Plus bath.

*) Stainless steel handle and Rosa II handle cannot be combined with a bath screen.

Note: The Rosa II bath can be complemented by the CVSK1 or VSK2 bath screen (see p. 197).

The products are as standard delivered within 14 days.

Bath Rosa 95

*Small in Size,
But Huge in Possibilities*

*We gave asymmetric baths their name.
If you want quality, ask for RAVAK.*

Rosa 95 Bath



A spacious shower enclosure together with a comfortable bath

The showering part of the bath has a flat bottom and integrated seat, and in combination with the bath screen provides an ideal showering space. The bathing part has a nicely gradual slope of the back portion inviting for comfortable bathing.

Maximum comfort, space-saving outer dimensions

Keeps the exceptional features of the Rosa baths and yet fits into smaller bathrooms thanks to its width of 95 cm.



Headrest Rosa 95
Colour: white, grey

Handle*
Universal stainless steel

Product (type)	Price
BATH	
Rosa 95 L/R 150x95	✓
Rosa 95 L/R 160x95	✓
SUPPORTS + PANELS + PANELKITS	
Support Rosa 95	✓
Rosa 95 - 150 L/R	✓
Rosa 95 - 160 L/R	✓
Panelkit	✓



L - left hand product option. R - right hand product option.

*) The handle cannot be combined with a bath screen.

Note: The Rosa 95 bath can be complemented by the CVSK1 or VSK2 bath screens (see p. 197).

The products are as standard delivered within 14 days.

Bath Rosa I

A reliable bath for everybody

*We gave asymmetric baths their name.
If you want quality, ask for RAVAK.*



Rosa I Bath



A spacious shower enclosure together with a comfortable bath

The showering part of the bath has a flat bottom and integrated seat, and in combination with a bath screen it provides an ideal showering space. The bathing part has a nicely gradual slope of the back portion inviting for comfortable bathing.

Historically, the most favourite bath on the market.

An affordable price, quality, and utility features, smartly combined.



Rosa I Headrest
Colour: white, grey

Rosa I Handle
Colour: white, grey

Rosa I Handle
stainless steel*

Product (type)	Price
BATH	
Rosa I L/R 140x105	✓
Rosa I L/R 150x105	✓
Rosa I L/R 160x105	✓
SUPPORTS + PANELS + PANELKITS	
Support Rosa I	✓
Panel Rosa I 140 L/R	✓
Panel Rosa I 150 L/R	✓
Panel Rosa I 160 L/R	✓
Panelkit	✓



L - left hand product option. R - right hand product option.
 Note: The Rosa bath can be complemented by the CVSK1 or VSK2 bath screen (see p. 197).
 *) The handle cannot be combined with a bath screen.
 The products are as standard delivered within 14 days.

Bath Avocado

Maximum out of Minimum



Avocado Bath

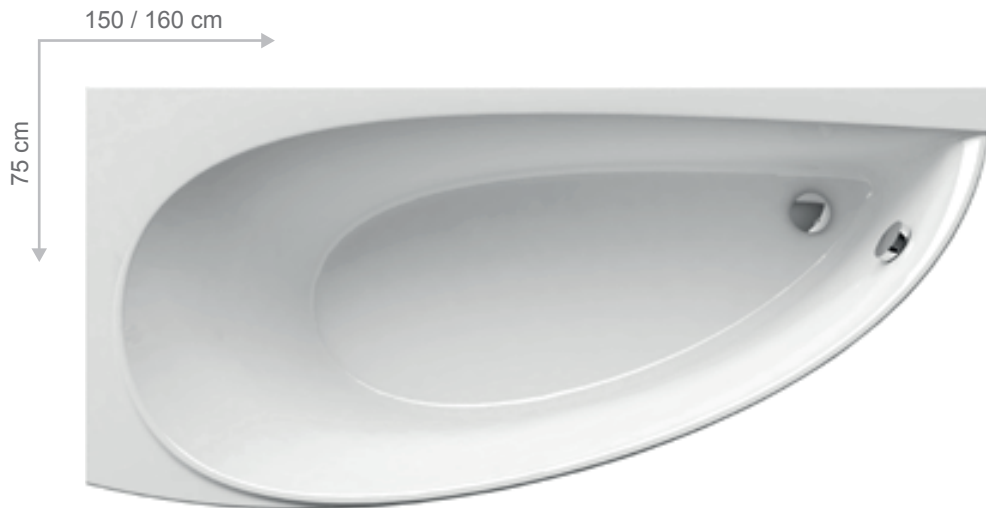

Maximum comfort, even with its small dimensions

Comfortable and economical, exactly where you will really appreciate it

Uniquely matched

With the washbasin creates an ingenious combination providing you with comfortable use



Product (type)	Price
BATH	
Avocado L/R 150x75	✓
Avocado L/R 160x75	✓
SUPPORTS + PANELS + PANELKITS	
Support Avocado	✓
Avocado 150 L/R	✓
Avocado 160 L/R	✓
Panelkit	✓



The Avocado Concept, see p. 38

L - left hand product option. R - right hand product option.
 Note: The Avocado bath cannot be complemented by a bath screen.
 The products are as standard delivered within 14 days.

Bath BeHappy

*The most space-saving
solution for comfortable
bathing and showering*



BeHappy Bath



A unique shape of the bath

Saves water and space in the bathroom and yet provides comfortable bathing

Bath screen

The bath combined with a well-fitting three-part bath screen allows comfortable showering



Headrest BeHappy
Colour: white

Product (type)	Price
BATH	
BeHappy L/R 150x75	✓
BeHappy L/R 160x75	✓
BeHappy L/R 170x75	✓
SUPPORTS + PANELS + PANELKITS	
Support BeHappy	✓
BeHappy 150	✓
BeHappy 160	✓
BeHappy 170	✓
Panelkit	✓



L - left hand product option. R - right hand product option.
Note: The BeHappy bath can be complemented by the VS3 bath screen (see p. 195).
The products are as standard delivered within 14 days.

Bath *Asymmetric*

Universal and keenly priced



Asymmetric Bath



Provides you with a view

The location of the wider part intended for the shoulders provides you with a view of the central part of the bathroom

Advantageous asymmetry

Compared to the other baths, its smaller dimensions still provide relatively large bathing space.



Length of the bath grows with its growing width.



Product (type)	Price
BATH	
Asymmetric L/R 150x100	✓
Asymmetric L/R 160x105	✓
Asymmetric L/R 170x110	✓
SUPPORTS + PANELS + PANELKITS	
Support Asymmetric	✓
Asymmetric 150 L/R	✓
Asymmetric 160 L/R	✓
Asymmetric 170 L/R	✓

L - left hand product option. R - right hand product option.
 Note: The Asymmetric bath cannot be complemented by a bath screen.
 The products are as standard delivered within 14 days.

Technical Drawings - Baths

Freedom R
175 x 75

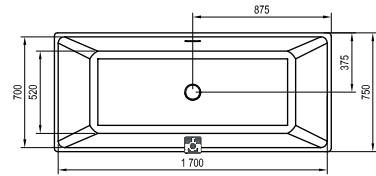
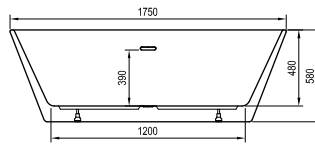

Freedom O
169 x 80

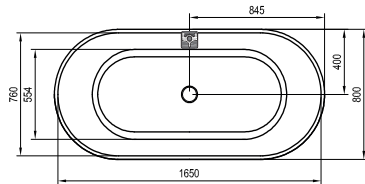
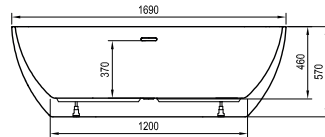

BathGallery
190 x 90

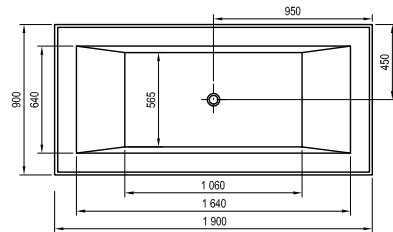
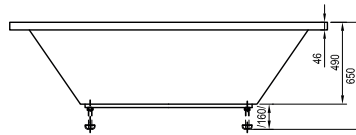

XXL
190 x 95

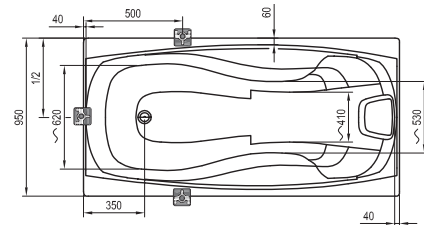
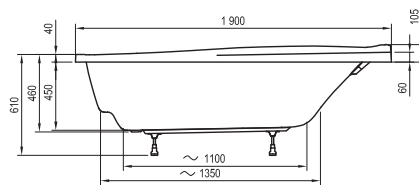

Evolution
180 / 170 x 102 - 87

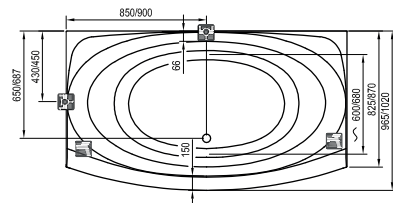
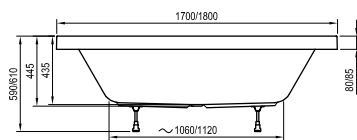

You
185 / 175 x 85

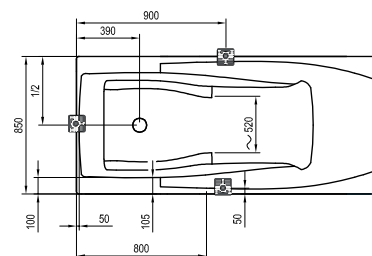
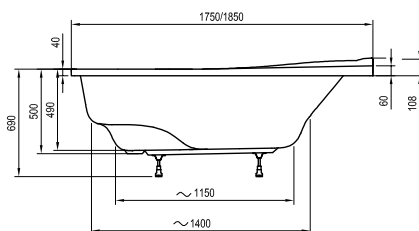

Magnolia
180 / 170 x 75

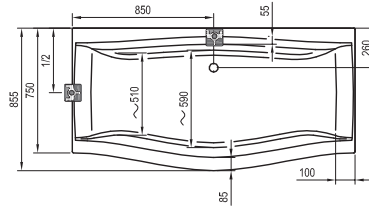
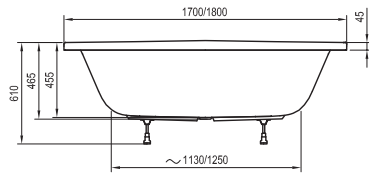

Sonata
180x80, 170 x 75

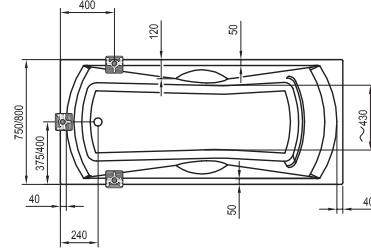
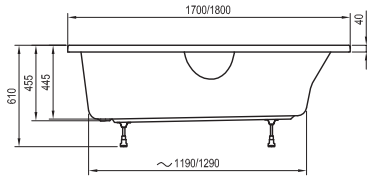

Campanula II
180x80, 170x75

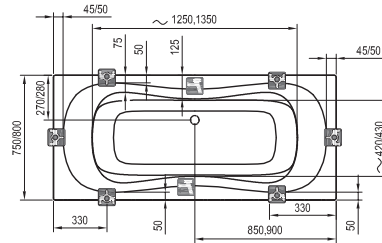
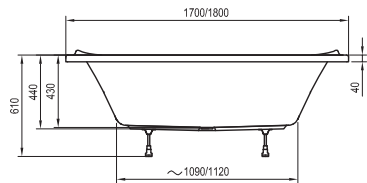

Chrome
170 x 75, 160 / 150 x 70

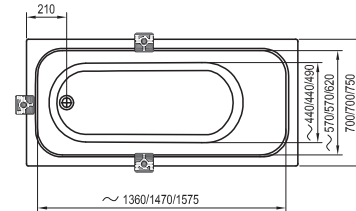
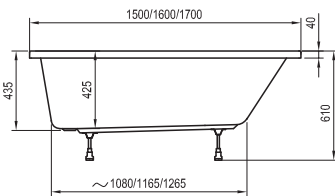

Classic
170 / 160 / 150 / 120 x 70

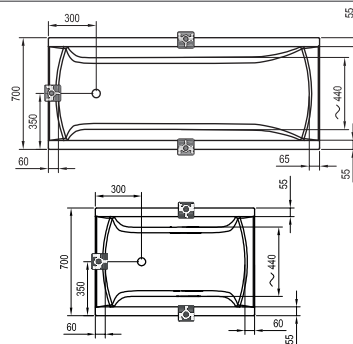
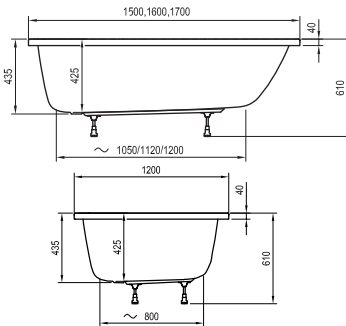

Vanda II
170 / 160 / 150 x 70

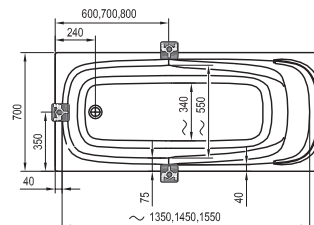
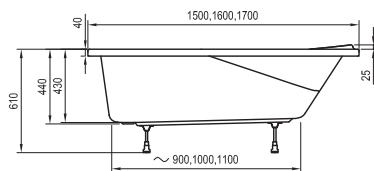

Technical Drawings - Baths

NewDay
150 x 150, 140 x 140

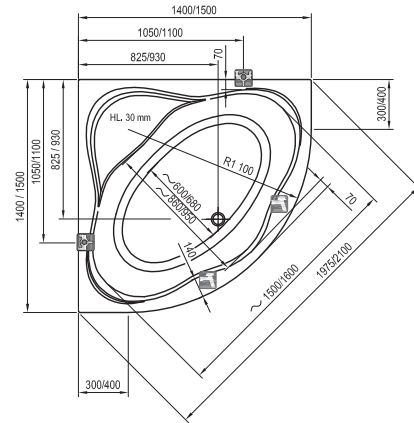
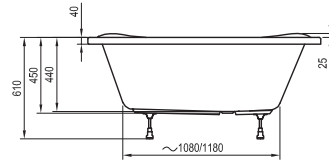

Gentiana
150 x 150, 140 x 140

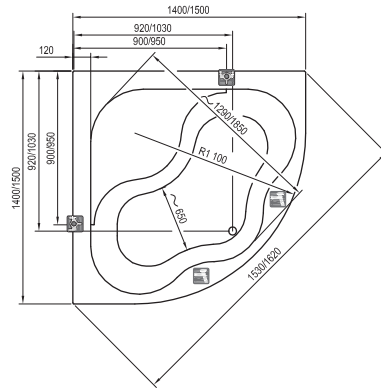
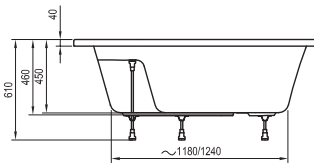

LoveStory II
196 x 139

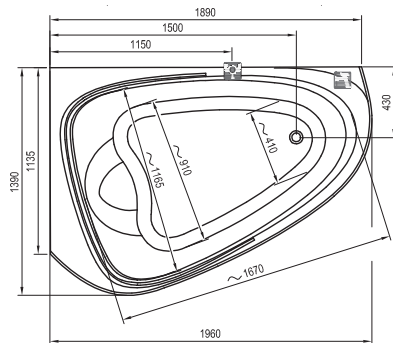
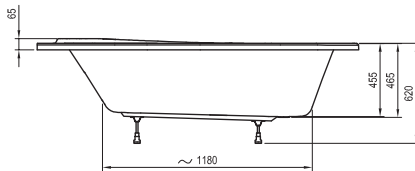

10°
170 x 100, 160 x 95

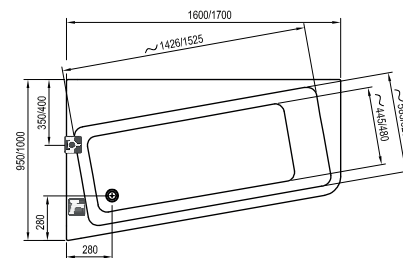
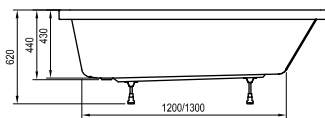
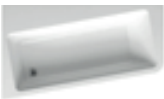

Rosa II
170 / 160 / 150 x 105

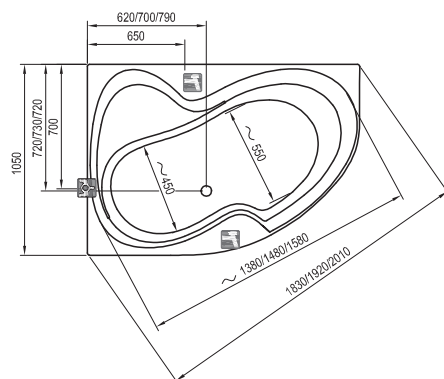
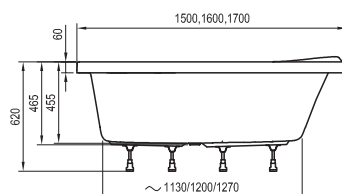

Rosa 95
160 / 150 x 95

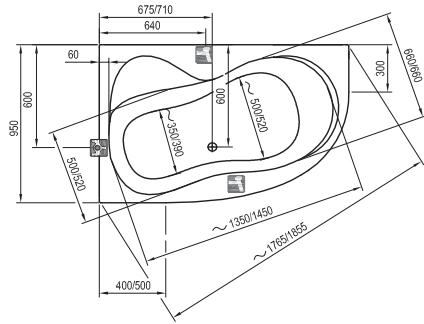
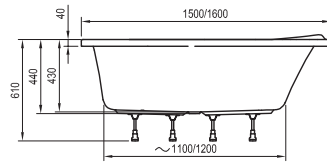

Rosa I
160 / 150 / 140 x 105

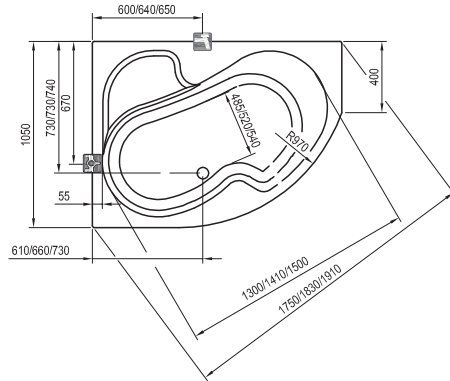
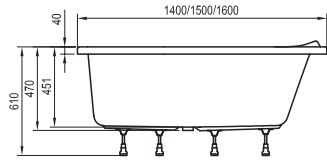

Avocado
160 / 150 x 75

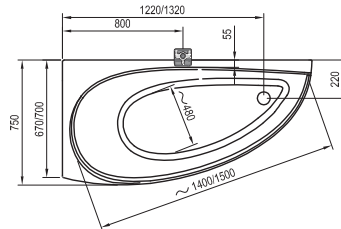
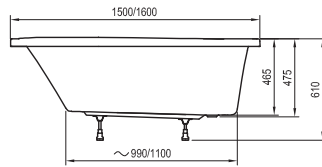

BeHappy
170 / 160 / 150 x 75

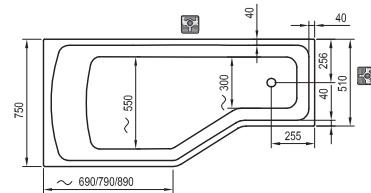
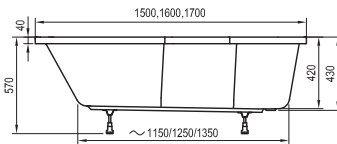

Asymmetric
170 x 110, 160 x 105, 150 x 100

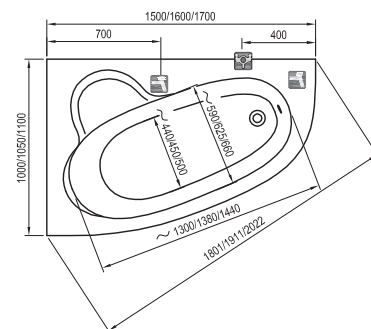
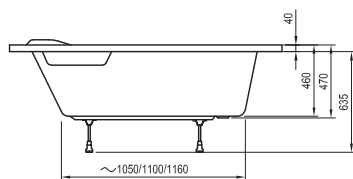

Bath accessories



Bath Drain Sets

Bath drain sets are suitable for all types of baths. They are made of top quality materials and differ by their technical and design solutions. We offer two basic types – **classic bath waste sets with an overflow** and **bath waste sets with an overflow filling**.

With regard to draining control, we manufacture **the ClickClack mechanism** (i.e. the outflow is closed by pressing the drain plug and opens by another pressing), or a system called **bowden cable system** (i.e. the trap cap is controlled by turning the top control to the open/closed position).

Bath waste sets with an overflow filling system



Bath waste set with an overflow filling system, the outflow is controlled by the **Bowden cable** mechanism



Bath waste set with an overflow filling system, the outflow is controlled by the **ClickClack** mechanism



Bath waste set with an overflow filling system, the outflow is controlled by the **Bowden cable** mechanism



Bath waste set with an overflow filling system, the outflow is controlled by the **ClickClack** mechanism

Classic bath waste trap sets with overflow



The bath waste set with overflow controlled by the **Click-Clack** system.



The bath waste set with overflow controlled by the **Bowden cable**.



The bath waste set with overflow controlled by the **Click-Clack** system. Length 800 mm



The bath waste set with overflow controlled by the **Bowden cable**. Length 800 mm

Cover strips



Cover strips

Used to seal the gap between the wall and the shower tray. They optimally cover and seal the gap so that cleaning is much easier than in the case of an unevenly applied sealant which spoils the appearance of the whole work when dirt settles on it. Cover strips can be purchased in the lengths of 1100 and 2000 mm and types 6, 10 or 11 mm. They are suitable for all types of shower trays and baths.

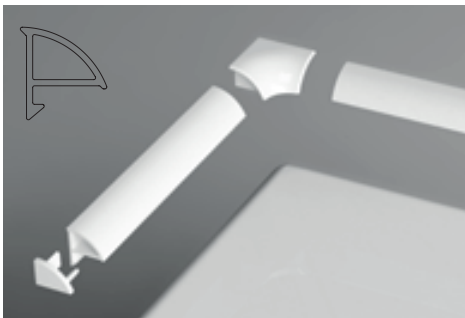

Cover strip 6

- seals gaps up to 6 mm
- it can be supplied with a set containing 2 cover strip end pieces (L,R) and 2 corner connectors

Cover strips	Price
Cover strip 6/1100 white	✓
Cover strip 6/2000 white	✓
Set for the cover strip 6	✓

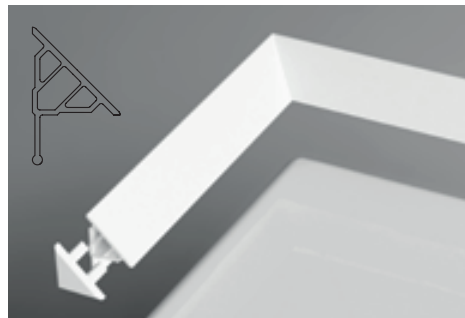

Cover strip 10

- seals a gap up to 10 mm
- can be complemented with an end piece
- cut at 45 degrees to create a corner

Cover strips	Price
Cover strip 10/1100 white	✓
Cover strip 10/2000 white	✓
Cover strip end piece 10 - white	✓

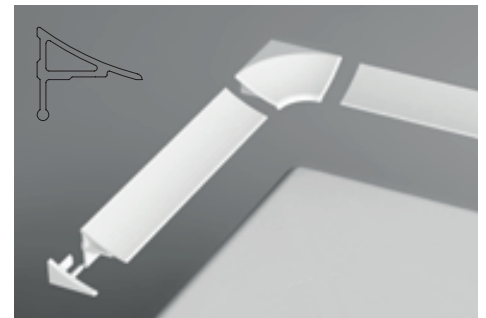

Cover strip 11

- seals gaps up to 11 mm
- it can be supplied with a set containing 2 cover strip end pieces (L/R) and 2 corner connectors

Cover strips	Price
Cover strip 11/1100 white	✓
Cover strip 11/2000 white	✓
Set for the cover strip 11	✓

The products are as standard delivered within 14 days.



RAVAK Professional sanitary silicone - 310 ml

RAVAK has tested and tried many silicones developed by major traditional manufacturers. One of the main requirements was the quality and durability of the sealed connections, as well as the ability to fix various materials used for shower enclosures, shower trays and baths together. Tests proved that it is almost impossible to choose a silicone that can adhere to glass, as well as to acrylic (PMMA), extruded polystyrene, aluminium, enamel, and many kinds of facing materials and tiles.

Therefore, RAVAK decided to co-operate with other manufacturers on developing their own silicone formula to fulfil all the above requirements.

RAVAK Professional sanitary silicone comes in two colours - white and clear (transparent).



Most of the baths are available with compatible handles and headrests made of coated dense polyurethane. Usual colours: white and grey.





Bath Screens and Doors

They can be mounted into a finished bathroom, both on the common shape and asymmetrically shaped baths.

Designed to keep the bathroom dry, prevent splashing water and allow comfortable showering while standing.

Universal Bath Screens



BVS1 one-piece fixed bath screen

It consists of rounded fixtures (B-SET) and a fixed transparent glass panel with a thickness of 8 mm.

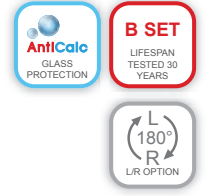

CHROME



Product (type)	Width (mm)	Price	Price (komplet)
BVS1 80	800	✓	✓
B SET	-	✓	

Height of the product is BVS1 - 1500 mm.
The products are as standard delivered within 14 days.



BVS2 two-piece movable bath screen

The screen consists of one fixed and one moveable part, which can be swung out of the bath. The thickness of the toughened glass is 8 mm on the fixed part and 6 mm on the moveable part.

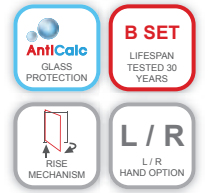

CHROME



Product (type)	Width (mm)	Price	Price (komplet)
BVS2 100 L/R	1000	✓	✓
B SET	-	✓	

BVS2 product height - 1500 mm. L - left hand product option. R - right hand product option.
Products are as standard delivered in 14 days.



CVS2 two-piece movable bath screen

The screen consists of one fixed and one moveable part, which can be turned out of the bath. The moveable part can thus be opened up at a maximum angle almost all the way to the washbasin. Thanks to the sophisticated opening method that respects the depth of the washbasin, it is much easier to clean the screen. The bath screen features a holder for better fixation.



GLOSS SATIN WHITE



Product (type)	Width (mm)	Safety glass panel		
		Frame finish Transparent decor		
		Frame finish		
		Gloss	Satin	White
CVS2 - 100 L/R	990	✓	✓	✓

Product height - 1500 mm.
The products are as standard delivered within 14 days.

Universal Bath Screens



PVS1 one-piece fixed bath screen

PVS1 consists of a vertical profile and one fixed piece. This simple and modern bath screen design is suitable for classic rectangular baths and fits into any bathroom.

With its width of 800 mm it provides enough space for comfortable showering.



Product (type)	Width (mm)	Safety glass panel - Transparent decor		
		White	Satin	Gloss
PVS1 - 80	800	✓	✓	✓

PVS1 product height - 1400 mm.
The products are as standard delivered within 14 days.



VS2 two-piece bath screen

VS2 consists of two parts that can be completely folded to the wall into the internal space above the bath.

When folded the screen takes up virtually no space. The width of the VS2 when opened is 1045 mm.

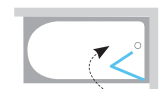

Product (type)	Width (mm)	Plastic panel		Safety glass panel			
		Rain decor		Transparent decor		Grape decor	
		White	Satin	White	Satin	White	Satin
VS2 105	1045	✓	✓	✓	✓	✓	✓

Height of VS2 - 1400 mm.
Products are as standard delivered in 14 days.



VS3 three-piece bath screen

VS3 consists of three parts. The widest VS3 model is 25 cm wider than the VS2 bath screen. It can also be folded to the wall to save space. A new feature is the possibility of turning the last screen piece towards the bath, which enables its use with the BeHappy bath, see page 137.



Product (type)	Width (mm)	Plastic panel		Safety glass panel			
		Rain decor		Transparent decor		Grape decor	
		White	Satin	White	Satin	White	Satin
VS3 100	996	✓	✓	✓	✓	—	—
VS3 115	1 146	✓	✓	✓	✓	—	—
VS3 130	1 296	✓	✓	✓	✓	✓	✓

Height of the product VS3 - 1400 mm. The VS3 100 bath screen is suitable for a 150cm bath, the VS3 115 for a 160cm bath and the VS3 130 for a 170cm bath.
The products are as standard delivered within 14 days.

Universal Bath Screens and Bath Doors



VS5 five-piece bath screen

VS5, the so-called concertina bath screen, is the most effective space-saving option as the screen can be folded against the wall when not in use. The width of the VS5 is 1135 mm.



WHITE



Product (type)	Width (mm)	Plastic panel		Safety glass panel			
		Rain decor		Transparent decor		Grape decor	
		Frame finish		Frame finish		Frame finish	
		White	Satin	White	Satin	White	Satin
VS5	1135	✓	—	—	—	—	—

Height of the product VS5 - 1330 mm.
The products are as standard delivered within 14 days.



AVDP3 bath door

Use the AVDP3 bath door to create a perfectly waterproof shower space above the bath. Turn the product 180 degrees to obtain either right hand or left hand entry option.



SATIN WHITE



Product (type)	En-trance (mm)	Width (mm)	Plastic panel		Safety glass panel			
			Rain decor		Transparent decor		Grape decor	
			Frame finish		Frame finish		Frame finish	
			White	Satin	White	Satin	White	Satin
AVDP3 - 120	661	1170 - 1210	✓ ■	✓ ■	✓ ■	✓ ■	✓ ■	✓ ■
AVDP3 - 150	861	1470 - 1510	✓	✓	✓ ■	✓ ■	✓ ■	✓ ■
AVDP3 - 160	928	1570 - 1610	✓	✓	✓ ■	✓ ■	✓ ■	✓ ■
AVDP3 - 170	995	1670 - 1710	✓	✓	✓ ■	✓ ■	✓	✓
AVDP3 - 180	1061	1770 - 1810	✓	✓	✓ ■	✓ ■	✓	✓

AVDP3 product height - 1370 mm. ■ Delivery takes 6 weeks.
The products are as standard delivered within 14 days.



AVDP3 + APSV

Do you need to create a maximum watertight shower enclosure above your bath? Use the combination of the AVDP3 bath door and APSV fixed wall.



The AVDP3 bath door can be widened by up to 2 cm using the ANPV extension profile. satin / white -

SATIN WHITE



Product (type)	Width (mm)	Plastic panel		Safety glass panel			
		Rain decor		Transparent decor		Grape decor	
		Frame finish		Frame finish		Frame finish	
		White	Satin	White	Satin	White	Satin
APSV - 70	670 - 705	✓	✓	✓ ■	✓ ■	✓ ■	✓ ■
APSV - 75	720 - 755	✓	✓	✓ ■	✓ ■	✓ ■	✓ ■
APSV - 80	770 - 805	✓	✓	✓ ■	✓ ■	✓ ■	✓ ■

AVDP3 + APSV height - 1370 mm. ■ Delivery takes 6 weeks.
The products are as standard delivered within 14 days.

Specific Bath Screens



10CVS2 two-piece bath screen

Designed for baths 10°. The screen can be moved into the inner space above the bath or out towards the wall.

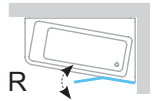

Product (type)	Width (mm)	Safety glass panel		
		Transparent decor		
		Frame finish		
		White	Gloss	Satin
10CVS2 100 L/R	990	✓	✓	✓

Height of 10CVS2 - 1500 mm. L - left hand product option. R - right hand product option. Products are as standard delivered in 14 days.



CVSK1 one-piece bath screen

Designed for the Rosa I, Rosa II, and Rosa 95 baths. The screen can be moved into the inner space above the bath or out towards the wall.

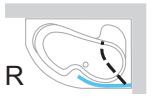
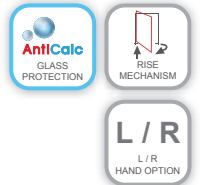

Product (type)	Width (mm)	Safety glass panel		
		Transparent decor		
		Frame finish		
		White	Gloss	Satin
CVSK1 140/150 L/R	850	✓	✓	✓
CVSK1 M 160/170 L/R	1000	✓	✓	✓

CVSK1 height - 1500 mm. L - left hand product option. R - right hand product option. Products are as standard delivered in 14 days.



VSK2 two-piece bath screen

Designed for the Rosa I, Rosa II, and Rosa 95 baths. For better stabilization we recommend fastening with the VSK2 short or long holder.



WHITE

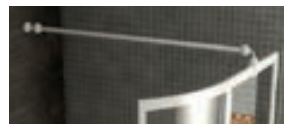

Short holder / Long holder
(The long holder can be used for the Rosa 95 bath)



Product (type)	Width of the fixed + folding part (mm)	Plastic panel	Safety glass panel	Compatible with
		Rain decor	Transparent decor	
		Frame finish	Frame finish	
		White	White	
VSK2 Rosa L/R 140	450 + 445	✓	✓	Rosa I 140
VSK2 Rosa L/R 150	480 + 445	✓	✓	Rosa II 150, Rosa I 150, Rosa 95
VSK2 Rosa L/R 160	535 + 445	✓	✓	Rosa II 160, Rosa I 160, Rosa 95
VSK2 Rosa L/R 170	635 + 445	✓	✓	Rosa II 170

VSK2 Rosa height - 1500 mm. L - left hand product option. R - right hand product option. Products are as standard delivered in 14 days.





Wellness

Relax at home

*The bath can become the highlight of the day.
Do not hurry, let the modern technologies spoil you for perfect body relaxation.*

RAVAK Hydro Massage Systems

- ▶ The RAVAK brand has been known for quality and production tradition since the previous century.
- ▶ We manufacture baths in the Czech Republic and each product is subjected to strict final inspection.
- ▶ The PU Plus reinforced baths are ideal for installation of the hydro massage systems.
- ▶ We use components manufactured solely by reputable companies in EU countries.
- ▶ All services and installations of the hydro massage systems are provided by our own service network.

RAVAK hydro massage systems offer **4 basic massage types**:



Intense water massage



Gentle air massage



Combined water and air massage

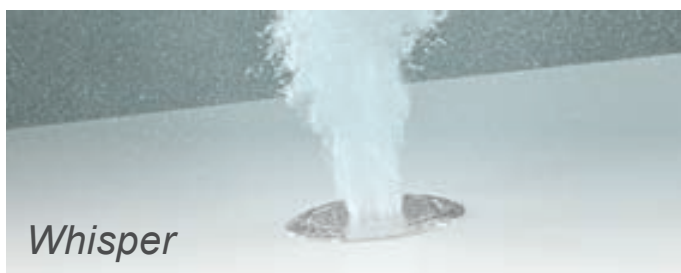

Exceptional water and air massage, unique by quiet and inexpensive operation

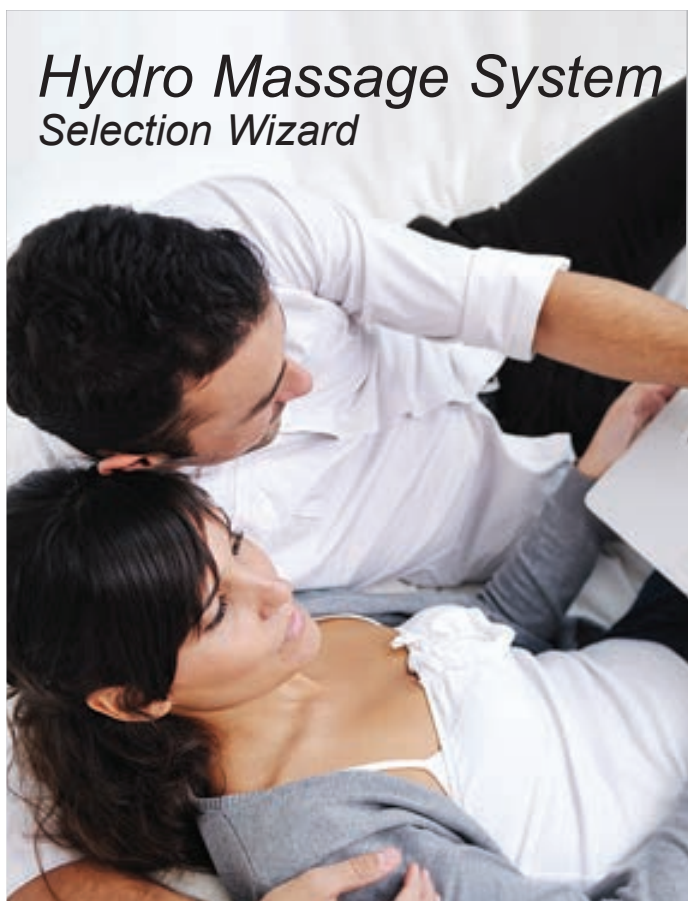

To select a massage bath with the required options and accessories, use our unique **Hydro Massage System Selection Wizard** at www.ravak.com

In seven easy steps, choose all the parameters, from the type of the bath to the accessories, while checking the total cost so that the resulting product suits all your requirements.

Tips for Selecting a Hydro Massage System

Sport Hydro/Air - a very popular system

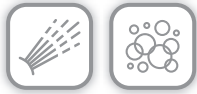

4x Super Jet

Enables adjustment of the stream of water in a 30 degree angle and regulation of its flow. When fully closed, the full massage intensity is focused on the micro-jets in the back and feet areas.

2x Air intake regulator

The air intake is divided into two circuits. Together with closable jets, you can therefore focus the massage intensity into one or the other half of the bath.

2x Pneumatic control ON/OFF

Independent controls for hydro massage and air massage.



6x Micro Jet

The thin stream of water can be adjusted in a 30 degree angle.

16x Air Jet

An increased number of metal jets is located in a pattern on the bottom in order to maximise their massage effect.

1x Suction

The cap of the safety suction.



The massage systems of the Sport range feature closable jets with air intake regulators which enable concentrating the water massage intensity into one or the other half of the bath. The Hydro/Air model is one of the most powerful systems.

Extra Flat Whisper - state-of-the-art system



4x jet Midi Extra Flat

The water flow from the metal jet can be adjusted in a 30 degree angle.

2x Suction

If one of the safety suction tube filters gets clogged, the other one secures sufficient water flow to the pump.

6x Micro Extra Flat Jet

Metal micro-jets provide focused massage of the feet and lower back. The thin stream of water can be adjusted in a 30 degree angle.



12x jet Magic Extra Flat

Metal jets have an independent air intake and using the Venturi effect they mix water and air to create a powerful massage field.

1x Pneumatic control ON/OFF

1x Control valve

The two-way valve allows fast and smooth switching between the side and bottom jets. In the central position all jets are turned on.

1x Independent air intake regulator

The regulator adds air to the water increase the massage effect.



The Extra Flat systems boast extra flat, all-metal jets and the control valve which allows fast and smooth switching between the individual massage jets. When combined with the Whisper system they provide the state-of-the-art type of massage ensuring perfect relaxation.

For more information, see the **Catalogue of Hydro Massage Systems** or visit www.ravak.com

Custom built hydro massage system for the **LoveStory II** bath

An intensive feeling of relaxation when bathing with a partner



The LoveStory II bath can be fitted with either Atomic or Atomic Plus hydro massage system that can fully substitute a traditional air bubble massage or hydro massage bath.



Special
massage jet



Chromotherapy



Suction

Product (type)	Price
BATH	
LoveStory II L/R 196x139	✓
LoveStory II PU Plus L/R 196x139	✓ <input type="checkbox"/>
SUPPORTS + PANELS + PANELKITS	
Support LoveStory II	✓
Panel LoveStory II L/R 196x139	✓
Panelkit LoveStory II	✓
HYDRO MASSAGE	
Atomic	✓
Atomic Plus	✓

Original electronic control unit



1. Blower ON button
2. Blower intensity control
3. Pump ON button
4. Chromotherapy ON button
5. Disinfection ON button,
Low/Empty disinfectant warning

Both the Atomic and Atomic Plus Systems include:

- 16x Special hydro massage jet
- 1x Chromotherapy feature
- 1x Electronic control unit

Additionally, the Atomic Plus system features:

- 1 x automatic disinfection unit
- 1 x water heating

Chromotherapy



Chromotherapy (healing with colour and light) is a standard feature of both the Atomic and Atomic Plus systems.

It uses 4 basic colours - red, yellow, green and blue to beneficially influence the organism. The colours slowly blend to enhance the colour spectrum, which amplifies the bath delight and helps your mind relax.

Note: Colour version available for the hydro massage systems: chrome.

The price of the hydro massage system includes a special waste set or a waste set with overflow filling for draining the hydro massage system.

L - left hand product option. R - right hand product option.

PU Plus bath.

Products are as standard delivered in 21 days.

We provide a 5-year warranty on baths fitted with the hydro massage system.

The warranty covers the bath and seal quality of the hydro massage system. The warranty for the hydro massage system is 24 months from the date of installation.

Hydro massage system tailored to the bath **You**

Now, you will not want to spend your leisure time anywhere else.



The You bath can be fitted either with the You Plus Hydro/Air or You Duo Hydro/Air hydro massage system which is designed to suit all figures, tall or short.



Suction inlet



Midi Jet



Hydro Jet



Air Jet



Underwater light fixture



Electronic control

Electronic control

The water-resistant electronic control is placed on the side of the bath so that it can be easily reached when filling the bath as well as bathing.

Product (type)	Price
BATH	in white colour
You 175x85	✓
You 185x85	✓
SUPPORTS + PANELS + PANELKITS	
Panel type	Panel price in white colour
Front panel You 175	✓
Front panel You 185	✓
Side panel You L/R 85	✓
HYDRO MASSAGE	
You Plus	Hydro / Air ✓
You Duo	Hydro / Air ✓

The You Plus Hydro/Air System included:

- 6 x hydro massage Midi Jet
- 4 x hydro massage Hydro Jet
- 14 x air massage Air Jet
- 1 x underwater LED light
- 2 x suction inlet
- 1 x special waste set with overflow filling
- 1 x water heating
- 1 x electronic control unit

The You Duo Hydro / Air System included in the bath :

- 6 x hydro massage Midi Jet
- 10 x hydro massage Hydro Jet
- 8 x air massage Air Jet
- 1 x underwater LED light
- 2 x suction inlet
- 1 x special drain set with overflow filling
- 1 x water heating
- 1 x electronic control unit

Underwater LED Light

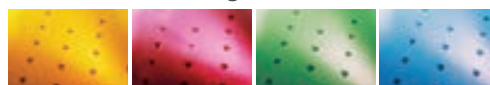

For the included underwater LED light, you can choose from several colours: white, yellow, red, green or blue. Please specify in the order which is your favourite.

Or, for an extra charge replace the LED light with the chromotherapy system with the STOP feature and you don't have to worry about choosing the colour. More at www.ravak.com

Note: The total cost of the hydro massage system includes a special waste set for draining the system. Due to the specific construction of the You hydro massage system, the waste set is included with the system, therefore you are not able to install a waste system of your own choice.

L - left hand product option. R - right hand product option.

Products are as standard delivered in 21 days.



Washbasins and Bathroom Furniture

Essential equipment of any bathroom

*You can choose simple modern lines of ceramic washbasins
or wide variety of cast washbasins.*



BathGallery Washbasins

New



design nosal[®]

Space for your own creativity
Color combinations of washbasin's bottom and accessories are available to your wish
The higher rim prevents the fall of objects

BathGallery Concept
 see p. 30



BathGallery washbasin

720 x 495 mm

The washbasin has a raised rim to prevent objects falling.

Possibility to add the plate in the basin.

Ideal for embedding or for tiling.

The washbasin doesn't have an overflow
 - it is necessary to use a fixed washbasin waste plug.

Washbasin plate

520 x 295 mm

Plate designed for the BathGallery washbasin. Available in five colours (white, blue, orange, green and yellow).

Possible to be encased in wood.

WASHBASINS	Dimensions (mm)	Price
BathGallery washbasin	720x495	✓
Plate for the Bath Gallery plate - white, blue, orange, green, yellow	520x295	✓

ACCESSORIES	Price
Washbasin Click-Clack waste plug	✓
Washbasin low Click-Clack waste plug	✓
Washbasin waste plug, fixed	✓
Waste trap U pipe	✓
Chromium-plated waste trap	✓
White console for the BathGallery washbasin	✓



BathGallery washbasin
 in combination with white
 console.

Cast marble washbasins come with a 35 mm hole for a standing tap only.
 Product dimensions: width x depth
 Products are as standard delivered in 6 weeks.
 Note: The console consists of a stainless steel frame and coated with white lining.

New



Life is not monochromatic. Combine colours of the soap dish and the box with the bottom of the washbasin so that the result suits your individual preferences. Play with the style and create your own look.

Colours of the extras:

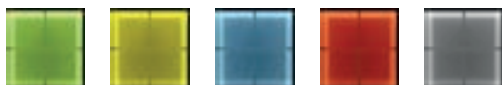

BathGallery Concept
see p. 30



Box

83 x 83 x 95 mm
Available in five colours



Box divider

77 x 77 x 95 mm
Only in clear colour.
Suitable especially for tooth brushes or decorative cosmetics.

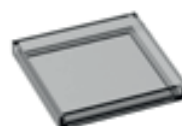

Soap dish

83 x 83 x 10 mm
Available in five colours

EXTRAS	Price
BathGallery box - blue, orange, green, yellow, grey	✓
BathGallery soap dish - blue, orange, green, yellow, grey	✓
Divider for the Bath Gallery box - clear	✓

Product dimensions are given as width x depth x height.
Products are as standard delivered in 6 weeks.

Washbasins 10°



*The washbasin which comes towards you
10° creates maximum comfort when washing
It perfectly matches the design of the bath with the same name*

Concept 10°
see p. 26



Washbasin 10°

550 / 650 x 450 / 480 mm

A sufficiently large washing space and comfortable shelves.

Can be combined with the SD 10° cabinet under washbasin.

Washbasin 10° corner

550 / 650 x 485 / 535 mm - L/R

The basin's slight rotation of 10 degrees into the space provides greater usability and comfort. There is no need to be pressed against the wall, arms can move freely during washing.

Can be combined with the corner SD 10° cabinet under washbasin.

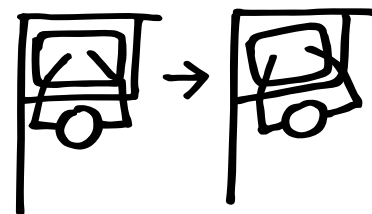

WASHBASINS	Dimensions (mm)	Price
Washbasin 10°	550x450	✓
Washbasin 10°	650x480	✓
Corner washbasin 10° L/R	550x485	✓
Corner washbasin 10° L/R	650x535	✓

ACCESSORIES	Price
Washbasin Click-Clack waste plug	✓
Washbasin low Click-Clack waste plug	✓
Waste trap U pipe	✓
Chromium-plated waste trap	✓

Cast marble washbasins come with a 35mm hole for a standing tap only.
Product dimensions: width x depth
Products are as standard delivered in 14 days.
Note: Products 10° available from 03/2015.

Bathroom furniture 10°



Ample storage space, Wide choice of colours, Special impregnation for humidity resistance

Cabinet finish:

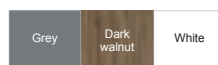

The cabinets are available in white glossy, grey semi-matt colour designs, or in the colour of dark walnut, always with an added white decorative stripe.

Concept 10°
see p. 26



SD 10°

550 / 650 x 450 x 450 mm
Cabinet with a practical drawer featuring ample storage space.
Designed for the washbasin 10°



SD 10° corner

550 / 650 x 485 / 535 x 450 mm - L/R
Cabinet with a shelf featuring ample storage space.
Designed for the corner washbasin 10°



SB 10°

450 x 290 x 1600 mm
High column cabinet with three shelves.

FURNITURE	Dimensions (mm)	Price
SD 10°	550x450x450	✓
SD 10°	650x450x450	✓
Corner SD 10° L/R	550x485x450	✓
Corner SD 10° L/R	650x535x450	✓
SB 10°	450x290x1600	✓

For complete solution and design harmony of the bathroom, we recommend you to combine with the 10° bath.

▶ see p. 170

Product dimensions: width x depth x height
The products are as standard delivered within 14 days.
Note: Products 10° available from 03/2015.

Chrome Washbasins



High strength and resistance
Simple modern lines
Very easy cleaning

Chrome Concept
 see p. 28



Washbasin Chrome

550 x 470 mm
 Can be combined with the SD
 Chrome 550 cabinet under
 washbasin.



Washbasin Chrome

650 x 470 mm
 Can be combined with the SD
 Chrome 650 cabinet under
 washbasin.



Option without the cabinet

WASHBASINS	Dimensions (mm)	Price
Chrome 550	550x470	✓
Chrome 650	650x470	✓

ACCESSORIES	Price
Washbasin Click-Clack waste plug	✓
Washbasin low Click-Clack waste plug	✓
Waste trap U pipe	✓
Chromium-plated waste trap	✓

Chrome washbasins will elegantly complement other products of the Chrome range (bath, shower enclosure, water taps etc).

▶ see p. 28

Ceramic washbasins come with a 35mm hole for a standing tap only. Product dimensions: width x depth
 Products are as standard delivered within 14 days.

Bathroom furniture under the **Chrome** ceramic washbasins



**A lot of shelf space
In grey and white colours
Special waterproof finish**

Colour design:

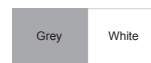

The cabinets are available in white glossy or grey semi-matt colour designs.

Chrome Concept
see p. 28



SD Chrome

515 x 450 x 450 mm
A cabinet with a high drawer featuring ample storage space.
The cabinet is designed under the Chrome 550 washbasin.



SD Chrome

615 x 450 x 450 mm
A cabinet with a high drawer featuring ample storage space.
The cabinet is designed under the Chrome 650 washbasin.



Chrome Water taps and accessories - p. 238

FURNITURE	Dimensions (mm)	Price
SD Chrome 550	515x450x450	✓
SD Chrome 650	615x450x450	✓

Product dimensions: width x depth x height
The products are as standard delivered within 14 days.

Chrome cast marble washbasins



Pleasantly large surfaces
Rounded internal space for comfortable use
Simple style in a timeless design

Chrome Concept
see p. 28



Chrome Small Washbasin

400 x 220 mm - L/R

An individual small washbasin which can be mounted onto the wall. It does not have an overflow - it is necessary to use a fixed washbasin waste plug. Can be supplemented by a cabinet or a towel bar.



Washbasin Chrome

600 / 700 / 800 x 490 mm

Can be combined with the cabinet under washbasin SD Chrome 600 / 700 / 800 and the Chrome mirror.

Newly in two designs - with an overflow and with a hidden overflow.



Chrome Double Washbasin

1200 x 490 mm

Double washbasin - maximum user comfort multiplied by two.

Can be combined with the SD Chrome 1200 cabinet under the double washbasin.

Newly in two designs - with an overflow and with a hidden overflow.

WASHBASINS	Dimensions (mm)	Price
Chrome 400 L/R	400x220	✓
Chrome 600	600x490	✓
Chrome 600 with a hidden overflow	600x490	✓
Chrome 700	700x490	✓
Chrome 700 with a hidden overflow	700x490	✓
Chrome 800	800x490	✓
Chrome 800 with a hidden overflow	800x490	✓
Chrome 1200	1200x490	✓
Chrome 1200 with a hidden overflow	1200x490	✓

ACCESSORIES	Price
Washbasin Click-Clack waste plug	✓
Washbasin low Click-Clack waste plug	✓
Washbasin waste plug, fixed	✓
Waste trap U pipe	✓
Chromium-plated waste trap	✓



The Chrome washbasin and double washbasin are available in the variant with a hidden overflow which is integrated in it.

L - left sided option, R - right sided option. Cast marble washbasins come with a 35-mm hole for a standing tap only. Product dimensions: width x depth. Products are as standard delivered within 14 days.

Note: The Chrome small washbasin needs to be equipped with the fixed washbasin waste plug.

Bathroom furniture under the **Chrome** ceramic washbasins



Ample storage space
Practical oval shape of the chromium-plated handle
Special waterproof finish

Cabinet finish:

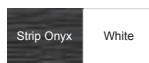

The cabinets are available with doors in white gloss only.

Chrome Concept see p. 28



Chrome mirror

600 / 700 / 800 x 70 x 550 mm
 Mirror featuring an integrated light fixture with a distinctive shape.

The mirror is designed under the Chrome washbasin 600 / 700 / 800.



SD Chrome

400 x 220 x 500 mm - L/R
 Cabinet with a shelf.

The door needs to be ordered separately in either left or right hand option!
 The cabinet is designed under the Chrome small washbasin 400.



SD Chrome

600 / 700 / 800 x 490 x 470 mm
 Cabinet with a high drawer offering ample storage space in a height of 40 cm.

The cabinet is designed under the Chrome washbasin 600 / 700 / 800.



SD Chrome

1200 x 490 x 470 mm
 Cabinet equipped with two high drawers (40 cm).

The cabinet is designed under the Chrome double washbasin 1200.



SB Chrome

350 x 370 x 1200 mm - L/R
 High column cabinet with three glass shelves.

FURNITURE	Dimensions (mm)	Price
Mirror Chrome 600	600x70x550	✓
Mirror Chrome 700	700x70x550	✓
Mirror Chrome 800	800x70x550	✓
SD Chrome 400	400x220x500	✓
Door Chrome 400 L/R	375x25x530	✓
SD Chrome 600	600x490x470	✓
SD Chrome 700	700x490x470	✓
SD Chrome 800	800x490x470	✓
SD Chrome 1200	1200x490x470	✓
SB Chrome 350 L/R	350x370x1200	✓

L - left sided option, R - right sided option.
 Product dimensions: width x depth x height
 The products are as standard delivered within 14 days.





Evolution washbasins



design **nosál**[®]

Unique design

Unique shape of the front rim

The washbasin together with the cabinet create a perfect design unit

Evolution Concept
see p. 32



Evolution Washbasin with an overflow

700 x 550 mm

The washbasin can be placed individually into the bathroom or combined with the SD cabinet under washbasin or SDS Evolution with the bar or drawer.



The Evolution washbasin with a hidden overflow

700 x 550 mm

The washbasin can be placed individually into the bathroom or combined with the SD cabinet under washbasin or SDS Evolution with the bar or drawer.

WASHBASINS	Dimensions (mm)	Price
Evolution Washbasin	700x550	✓
Evolution washbasin with a hidden overflow	700x550	✓

ACCESSORIES	Price
Washbasin Click-Clack waste plug	✓
Washbasin low Click-Clack waste plug	✓
Waste trap U pipe	✓
Chromium-plated waste trap	✓

Cast marble washbasins come with a 35-mm hole for a standing tap only.

Product dimensions: width x depth

Products are as standard delivered within 14 days.

Evolution Bathroom Furniture



Ample storage space
In a white colour with high gloss
Special impregnation providing humidity resistance

Cabinet finish:



The cabinets are available with doors in white gloss only.

The Evolution Concept see p. 32



New



Mirror Evolution

700 x 125 x 700 mm
 Mirror with a useful shelf.



SD Evolution with a horizontal bar

700 x 550 x 400 mm
 Cabinet with a practical, chromium-plated metal bar for hanging towels offering large shelf space.

Designed under the Evolution washbasin.



SDS Evolution with drawer

700 x 550 x 400 mm
 Cabinet with a practical drawer featuring ample storage space.

Designed under the Evolution washbasin.

New



SB Evolution, open

450 x 305 x 1420 mm
 High column cabinet with four wooden shelves.

New



SB Evolution closed

450 x 305 x 1420 mm
 High column cabinet with five glass shelves.

FURNITURE	Dimensions (mm)	Price
Mirror Evolution	700x125x700	✓
Glass shelf with fittings	700x160x6	✓
SD Evolution with a bar	700x550x400	✓
SDS Evolution with a drawer	700x550x400	✓
SB Evolution, open	450x305x1420	✓
SB Evolution, closed	450x305x1420	✓

Product dimensions: width x depth x height

The products are as standard delivered within 14 days.

Note: The Evolution mirror and the high column cabinets will be available from 03/2015.



Evolution Glass Shelf

700 x 160 x 6 mm
 Glass shelf with a rounded front rim and chromium-plated metal fittings.

For complete solution and design harmony of the bathroom, we recommend you to combine with the Evolution bath.

► see p. 146

Rosa Washbasins



Practical storage surface

Handy towel bar

The washbasin together with the cabinet create a harmonious design unit

Rosa Concept
see p. 34



right
option

Rosa Washbasin

566 x 466 mm - L/R

The smallest washbasin of the Rosa Concept designed for smaller bathrooms.

It can be combined with the SDU Rosa cabinet under washbasin and the mirror M 560.



right
option

Rosa Comfort Washbasin for Cabinet

780 x 550 mm - L/R

The Rosa Comfort washbasin for cabinet comes in the same dimensions as the Rosa Comfort, only the horizontal bar is missing.

It can be combined with the SDU Rosa Comfort cabinet under washbasin and the mirror M 780.



The Rosa water tap,
see p. 248

WASHBASINS	Dimensions (mm)	Price
Rosa L/R	566x466	✓
Rosa Comfort for furniture L/R	780x550	✓

ACCESSORIES	Price
Washbasin Click-Clack waste plug	✓
Washbasin low Click-Clack waste plug	✓
Waste trap U pipe	✓
Chromium-plated waste trap	✓

For the complete concept and unified bathroom design we recommend combining the Rosa washbasin with the bath and other products of the Rosa Concept.

► see p. 34

L - left sided option, R - right sided option.

Cast marble washbasins come with a 35-mm hole for a standing tap only.

Product dimensions are specified as width x depth

Products are as standard delivered within 14 days.

Rosa Bathroom Furniture



Ample storage space
Hanging system for easy cleaning
Wide offer of types and colours

Cabinet finish:

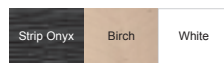

The cabinets are available with doors in white gloss only.

The Rosa Concept see p. 34



M 560

566 x 30 x 800 mm
 Mirror with an integrated light.
 Designed above the Rosa washbasin. Not available in Strip Onyx finish.



M 780

780 x 160 x 680 mm - L/R
 Mirror equipped with a shelf, integrated spotlights, and a socket outlet for a shaver.
 Designed above the Rosa Comfort and Rosa Comfort furniture washbasins.

right hand option



SDU Rosa

560 x 400 x 240 mm - L/R
 Cabinet with a drawer.
 Designed under the Rosa washbasin.
 The cabinet is not available in Strip Onyx finish.

right hand option



SDU Rosa Comfort

780 x 550 x 680 mm - L/R
 Cabinet equipped with a drawer and integrated laundry basket.
 Designed under the Rosa Comfort washbasin for cabinet.

left hand option



SB Rosa

410 x 350 x 1800 mm - L/R
 High column cabinet equipped with two glass shelves and wide shelf space.

Reverse the cabinet for left or right hand option.

FURNITURE	Dimensions (mm)	Price
M 560	566x30x800	✓
M 780 L/R	780x160x680	✓
SDU Rosa L/R	560x400x240	✓
SDU Rosa Comfort L/R	780x550x680	✓
Rosa L/R	410x350x1800	✓

ACCESSORIES	Price
Supportive legs MR Base	✓

Furniture can be installed onto adjustable legs with a height from 10 up to - 12 cm.

L - left sided option, R - right sided option.
 Product dimensions: width x depth x height

The products are as standard delivered within 14 days.

Classic Washbasins



design nosal®

Shelf space for all your bath necessities
Comfortably deep washbasins providing ample washing space
Classic shape suitable for placing in a corner

The Classic Concept
see p. 36



New



Classic small washbasin

400 x 220 mm
 The washbasin can be combined with the SD Classic 400 cabinet under washbasin.
 The Classic small washbasins can be installed onto a wall using chromium-plated consoles.



Classic Washbasin

600 / 700 x 490 mm
 Can be combined with the cabinet under washbasin SD Classic 600 / 700 and mirror Classic 600 / 700.



right option

Classic Washbasin

800 x 490 mm - L/R
 Features large shelf space. Can be combined with the cabinet under washbasin SD Classic 800 and mirror Classic 800.



Classic double washbasin

1300 x 490 mm
 A double washbasin with ample shelf space for comfortable washing.
 Can be combined with the cabinet under double washbasin SD Classic 1300.

WASHBASINS	Dimensions (mm)	Price
Classic 400	400x220	✓
Classic 600	600x490	✓
Classic 700	700x490	✓
Classic 800 L/R	800x490	✓
Classic 1300	1300x490	✓

ACCESSORIES	Price
Washbasin Click-Clack waste plug	✓
Washbasin low Click-Clack waste plug	✓
Waste trap U pipe	✓
Chromium-plated waste trap	✓
Chromium-plated consoles for the Classic Mini small washbasin -2 pcs	✓

L - left sided option, R - right sided option.
 Cast marble washbasins come with a 35-mm hole for a standing tap only.
 Product dimensions: width x depth
 Products are as standard delivered within 14 days.

Classic Bathroom Furniture



Generous storage space
Special depth impregnation and surface finish which helps prevent humidity

Cabinet finish:

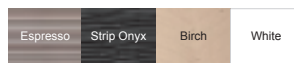

The cabinets are available with doors in white gloss only.

Classic Concept see p. 36



Classic mirror

600 / 700 / 800 x 70 x 550 mm
 Mirror equipped with an integrated light fixture and a practical socket outlet for a shaver.

The mirror is designed above the Classic washbasin 600 / 700 / 800.



SD Classic

400 x 220 x 500 mm - L/R
 Cabinet with a shelf.

The door needs to be ordered separately in either left or right hand option!

The cabinet is designed under the Classic small washbasin



right hand option

SD Classic

600 / 700 / 800 x 490 x 470 mm (SD Classic 800 - L/R)
 Cabinet with a high drawer offering ample storage space in a height of 40 cm.

The cabinet is designed under the Classic washbasin 600 / 700 / 800.



SD Classic

1300 x 490 x 470 mm
 Cabinet equipped with two high drawers (40 cm). The right hand part under the washbasin features an integrated drawer for small items. Optionally, it is available for the other part as well.

The cabinet is designed for the Classic double washbasin 1300.



SB Classic

350 x 370 x 1200 mm - L/R
 High column cabinet with two glass shelves and a handy drawer at the top.



Special impregnation and surface treatment to provide water resistance.

FURNITURE	Dimensions (mm)	Price
Mirror Classic 600	600x70x550	✓
Mirror Classic 700	700x70x550	✓
Mirror Classic 800	800x70x550	✓
SD Classic 400	400x220x500	✓
Door Classic 400 L/R	375x25x530	✓
SD Classic 600	600x490x470	✓
SD Classic 700	700x490x470	✓
SD Classic 800 L/R	800x490x470	✓
SD Classic 1300	1300x490x470	✓
SB Classic L/R	350x370x1200	✓

L - left sided option, R - right sided option.
 Product dimensions: width x depth x height
 The products are as standard delivered within 14 days.

Praktik washbasin and mirror



Well thought-out shelf space
Rounded corner leaves more room for you to walk through
The washbasin together with the cabinet create a sophisticated whole



left hand option

Praktik U Washbasin

780 x 490 mm - L/R
 Designed into the corner or right next to the bath.

Can be combined with the M 780 mirror.



left hand option

Praktik S Washbasin

960 x 490 mm - L/R
 It features shelf space on both sides. The "wet" shelf is placed lower than the "dry" one, and serves to keep things that drip water e.g. a toothbrush. The "dry" shelf is placed higher and serves to keep dry such things as a shaver.

Can be combined with the SDZU Praktik S cabinet.



left hand option

Praktik W Washbasin

1160 x 650 mm - L/R
 Designed to be placed over the washing machine; the large shelf area is not connected with the machine so the spinning does not cause any vibration.

WASHBASINS	Dimensions (mm)	Price
Praktik U L/R	780x490	✓
Praktik S L/R	960x490	✓
Praktik W L/R	1160x650	✓

MIRROR	Dimensions (mm)	Price
M 780 L/R	780x160x680	✓

ACCESSORIES	Price
Washbasin Click-Clack waste plug	✓
Washbasin low Click-Clack waste plug	✓
Waste trap U pipe	✓
Chromium-plated waste trap	✓



right hand option

M 780

780 x 160 x 680 mm - L/R
 Mirror equipped with a shelf, integrated spotlights and a socket outlet.

The M 780 mirror is designed over the Praktik U washbasin.

L - left sided option, R - right sided option.
 Cast marble washbasins come with a 35-mm hole for a standing tap only.
 Product dimensions: width x depth
 Products are as standard delivered within 14 days.

Praktik washbasins and mirror



Washbasins Avocado



design **nosál**®

Generous shelf space
Washbasin mounted above the bath saves space
Original design

Avocado Concept
 see p. 38



85 / 95
 cm
 WIDTH



Right hand option



Right hand option

Avocado Washbasin

850 x 450 mm - L/R

The washbasin features generous shelf space and perfectly harmonises with the Avocado bath, thus creating a beautiful unit.

When mounted above the narrow part of the bath, the washbasin takes up minimum space.

Avocado Comfort Washbasin

950 x 450 mm - L/R

The washbasin provides even more shelf space and comfort for washing.

This washbasin is also designed above the Avocado bath.



Avocado Concept

WASHBASINS	Dimensions (mm)	Price
Avocado L/R	850x450	✓
Avocado Comfort L/R	950x450	✓

ACCESSORIES	Price
Washbasin Click-Clack waste plug	✓
Washbasin low Click-Clack waste plug	✓
Waste trap U pipe	✓
Chromium-plated waste trap	✓

L - left sided option, R - right sided option.

Cast marble washbasins come with a 35-mm hole for the standing tap only.

Product dimensions are specified as width x depth

Products are as standard delivered within 14 days.

BeHappy Washbasin



When placed above the bath, the washbasin becomes a unique space-saving solution
Comfortably large shelf space
Available in both left and right hand option

BeHappy Concept
see p. 39

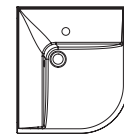

Left hand option

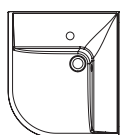

Right hand option

BeHappy Washbasin

570 x 500 mm - L/R

Designed to be mounted individually into the corner above the BeHappy bath. This unique solution of placing the washbasin above the bath saves space while retaining all comfort for those who use it.

WASHBASINS	Dimensions (mm)	Price
BeHappy L/R	570x500	✓

ACCESSORIES	Price
Washbasin low Click-Clack waste plug	✓
Waste trap U pipe	✓

The right or left sided washbasin is identified by the corner in which the basin will be mounted. The water tap must always be right opposite you.



L - left sided option, R - right sided option.
 The cast marble washbasin comes with a 35mm hole for a standing tap only.
 Product dimensions: width x depth
 Products are as standard delivered within 14 days.

Washbasin accessories



Washbasin wastes and traps

We offer washbasin waste plugs for all applications. The low waste plug is suitable for use with furniture where it saves space and it is recommended to be combined with the waste trap U pipe.

The classic waste plug looks smart if the washbasin is placed without furniture and can be combined with the brass waste trap. The fixed waste plug has to be used for small washbasins without an overflow, it prevents from spilling of the basin.

Sink Accessories



Washbasin fixed waste plug designed for small washbasins without an overflow



Washbasin ClickClack waste plug for all types of washbasins



Washbasin low ClickClack waste plug for all types of washbasins

Suitable for the washbasin with furniture where it saves space.



Washbasin waste trap U pipe for all types of washbasins

Suitable for the washbasins with furniture.



Washbasin brass waste trap for all types of washbasins





3

2

Chrome Concept for WC



1

WC and Accessories

2

Small Washbasin with Furniture

3

Water Taps

4

Bathroom Accessories

4

1



Chrome WC and Bidet



Ceramic – easy maintenance and cleaning
Part of the Chrome Concept
Long life

Chrome Concept
 see p. 28



Chrome WC

360 x 530 x 347 mm
 Hanging system for easy cleaning of the bathroom. Hidden installation which does not spoil the look.
 Efficient system of flushing, leaves the toilet bowl clean.



Chrome bidet

365 x 530 x 295 mm
 Hanging system for easy cleaning of the bathroom.
 Hidden installation which does not spoil the look.

WC AND BIDET	Dimensions (mm)	Price
Chrome WC	360x530x347	✓
Chrome Bidet	365x530x295	✓



Small washbasin with the Chrome furniture, see p. 122



Chrome bidet water tap, see p. 238



Chrome bathroom accessories, see p. 240

Product dimensions are given as width x depth x height.
 Products are as standard delivered within 14 days.



Expansion of the existing Chrome Concept to achieve absolute perfectness



Chrome Control push buttons

247 x 165 mm
Harmonious shape of oval characterises the Chrome design of steel buttons. The mechanism is integrated in the wall so the buttons only slightly protrude.
Available in two designs:
Satin and White



Universal control push buttons

247 x 165 mm
Plastic buttons with surface treatment to make them scratch resistant.
Available in two designs:
Satin and White



Wall mounted installation module W

1062 x 592 x 145 - 220 mm
Basic module for hanging toilet designed to be set in the wall and tiled. The product includes an insulation sheet for WC. Economical, adjustable flushing between 2-3.5l / 6-9l.



Wall mounted installation module G

1076 x 510 x 180 - 295 mm
Framed module designed for hung toilets to be built in dry wall. The product includes an insulation sheet for WC. Economical, adjustable flushing between 2-3.5l / 6-9l.

Adding a bracket to the module creates an option suitable for mounting the toilet during refurbishment of sanitary units, for timbered houses, etc. Module installed in this way is self-supporting.



Chrome toilet seat

365 x 430 x 40 mm
A seat of rigid plastic, equipped with the Soft Close slow-down mechanism.

ACCESSORIES	Dimensions (mm)	Price
Control push button Chrome – satin	247x165	✓
Control push button Chrome – white	247x165	✓
Control push button Universal – satin	247x165	✓
Control push button Universal – white	247x165	✓
Wall mounted installation module W / 1000 for setting in the wall	1062x592x145-220	✓
Wall mounted installation module G / 1200 for dry wall	1076x510x180-295	✓
Bracket for the wall mounted installation module G	-	✓
Chrome toilet seat	365x430x40	✓

Product dimensions: width x depth x height
The products are as standard delivered within 14 days.





Water taps

Elegant, reliable and reasonably priced

Quality water taps create the basis of any bathroom. Choose the best materials, timeless design, solid manufacture and long life guarantee.

New

Water taps 10°

Coming towards you

10°



Water taps 10° are part of the 10° Concept.
See pages 26 - 27.

Modern design and not only that! The tap is 10° inclined towards your hand which makes its control easy and it is in harmony with every basin shape.

design nosal®

The 10° water taps were designed by the Czech designer Kryštof Nosál.



Adjustable aerator - makes adjustment of the water stream much easier.



Ceramic cartridge with 35 mm diameter is tested for a minimum life of 30 years.



The 10° water taps Ceramic cartridge with 35 mm diameter is 5 year warranty.



Water taps 10°

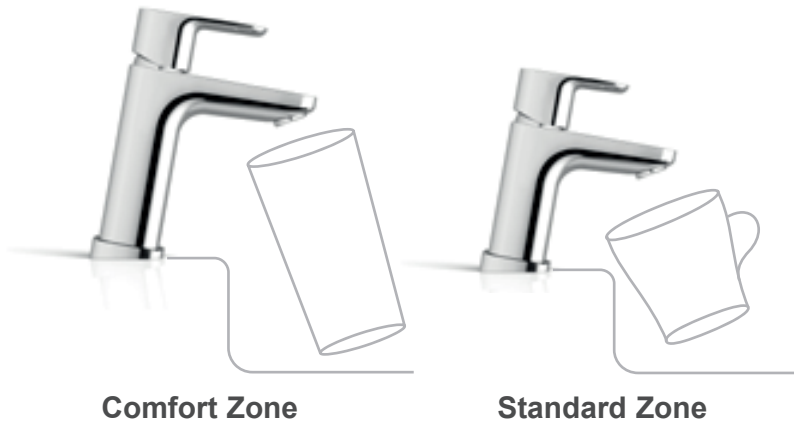

The 10° water tap can be of standard or extended height.

Choose the ideal size. Higher taps will create more comfortable space for washing. The flexible aerator will ensure that the flow of water will always go directly to the drain to prevent splashing of water.



Washbasin standing water tap
140 mm without the waste
TD 012.00

Washbasin standing water tap
170 mm without the waste
TD 014.00

Washbasin standing water tap
140 mm, with the waste
TD 011.00

Washbasin standing water tap
170 mm, with the waste
TD 013.00

Practical tilt of the water tap toward the hand and into the washbasin will make the usage more pleasant. Furthermore it is very easy to clean the space between the water tap and the wall.



Note: Products 10° will be available from 03/2015.

Concept 10°

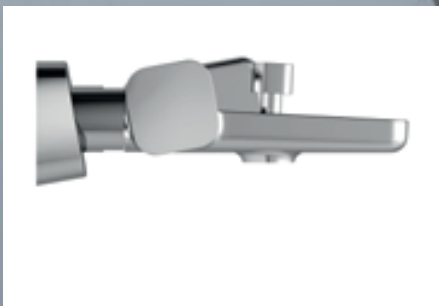

You will enjoy the dynamic interaction with the bath of the 10° concept. The sophisticated asymmetry adds the 10° bath water tap original style allowing easy control.

Water taps 10°



Bidet standing water tap
with the waste
TD 055.00



Wall-mounted bath water tap
without set
150 mm
TD 022.00 /150



Wall-mounted shower tap
without set
150 mm
TD 032.00/150



Bath/shower built-in tap
with diverter
TD 061.00



Shower built-in tap
without diverter ,
TD 062.00



Bath/shower built-in tap
with diverter, - for R-box
TD 065.00



Shower built-in tap
without diverter, - for R-box
TD 066.00

Mounting of the water tap on the wall is 10° inclined toward the hand.
The lever is comfortable to hold, but it is not obstructing when showering and taking a bath.



Note: Products 10° will be available from 03/2015.

Chrome

Security of style



Chrome water taps are part of the Chrome Concept. See pages 28 - 29.

The complete range of Chrome water taps will be in natural harmony with every bathroom. Clear minimalist lines match the other parts of the Chrome Concept.

design nosal[®]



Adjustable aerator - makes adjustment of the water stream much easier.



Ceramic cartridge with 35 mm diameter is tested for a minimum life of 30 years.



Chrome water taps have 5 year warranty.

Chrome water taps and accessories



Washbasin standing tap
without waste
CR 012.00



Washbasin standing tap
with waste
CR 011.00



Bidet standing tap
with waste
CR 055.00

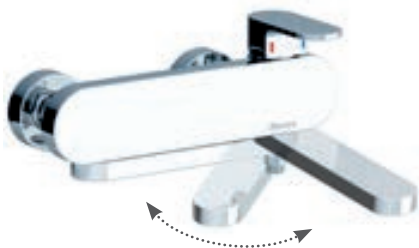

Wall-mounted bath mixer tap
with rotary spout without set
150 mm
CR 022.00/150



New
Spout
washbasin/bath
spout length 230 mm
CR 027.00



Wall-mounted shower tap
without set
150 mm
CR 032.00/150



Built-in bath/shower tap
with a diverter, - for R-box
CR 065.00



Built-in shower tap
without diverter, - for R-box
CR 066.00



Sink standing water tap
CR 016.00



New
Shower head Slim, Chrome
square 300 mm,
982.00



New
Shower head, Chrome
round - 1 function
957.00



New
Shower holder adjustable, Chrome
with a joint
611.00



New
Bar with a sliding shower holder, Chrome
70 cm
974.00

Note: New products will be available from 03/2015.

Chrome Bathroom Chrome accessories

Small details make great difference



Chrome bathroom accessories are part of the Chrome Concept. See pages 28 - 29.

A careful choice of the most popular accessories will harmonise any bathroom or WC. Durable and easy to clean materials will provide long-lasting satisfaction.



For cleaning of bathroom accessories, use RAVAK Cleaner Chrome or other non-aggressive detergents in order to prevent damage to the chromium surface layer.



Chrome bathroom accessories have 5 year warranty.

Bathroom Accessories



Holder with a glass
CR 210.00



Holder with two glasses
CR 220.00



Soap holder (glass)
CR 200.00



Soap dispenser (glass)
CR 231.00



Double hook
CR 100.00



Towel holder, oval
CR 300.00



Toilet paper holder
CR 400.00



Toilet brush holder (glass)
CR 410.00



**Towel holder
66 cm**
CR 310.00



**Towel holder
66 cm**
CR 320.00



**Towel rack
with a holder, 66 cm**
CR 330.00



**Glass shelf
64 cm**
CR 500.00



For products CR 200.00, 210.00 and 410.00 , you will switch between the right or left hand options by turning the product over and flipping the oval cover with the logo.





Freedom Water Tap

The tall slim silhouette of the tap with the spout creates a symphony of beauty and utility in the bathroom. The ability to mount the water tap anywhere in the floor provides an absolute freedom when creating a custom built bathroom.



For cleaning of water taps, use RAVAK Cleaner Chrome or other non-aggressive detergents in order to prevent damage to the chromium surface layer.



Function for simple cleaning of small shower nozzles. Limescale formed on the jets can be simply wiped off with a gentle touch of your hand.



Water taps are covered by a 5 year warranty.



**Floor mounted
bath tap**
FM 080.00



New

**Floor mounted
bath tap**
FM 081.00

A design set - an ideal combination
of the water tap and bathtub
Freedom.



Note: FM 081.00 bath taps available from 04/2015.

Thermo

Constant Water Temperature



The thermostatic tap will balance the changes of water pressure and temperature in the pipes, ensuring the water will maintain the temperature you have set. Once you have tried the thermostatic water tap, you will stand by it forever .



Easy way of scale removal.



For cleaning of water taps, use RAVAK Cleaner Chrome or other non-aggressive detergents in order to prevent damage to the chromium surface layer.



All thermostatic taps feature a ceramic cartridge for water flow control and a thermostatic cartridge for water temperature control. The water tap and both cartridges have 5 years warranty.

Thermo Water Taps



Thermostatic wall-mounted bath tap

without set
150 mm
TE 022.00/150



Thermostatic wall-mounted shower tap

without set
150 mm
TE 032.00/150



Thermostatic wall-mounted bath tap

without set
150 mm
TE 082.00/150



Thermostatic wall-mounted shower tap

without set
150 mm
TE 072.00/150



Thermostatic built-in bath/shower tap

with diverter
TE 061.00



Thermostatic built-in shower tap

without diverter
TE 062.00



Sliding shower column with a thermostatic tap

TE 091.00/150

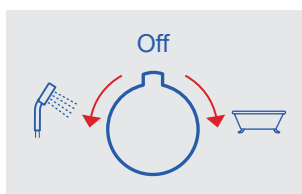

Integrated diverter

The bath/shower diverter integrated in the head for simple control.



Clear marking

Prevents mistaking hot for cold water.

Safety lock

Against unwanted change in water temperature above 38°C.

FastReaction

Reacts immediately to water pressure changes and keeps the mixed water at constant temperature.

Scald protection

Should there be a fault in the cold water inlet, it immediately decreases flow in the hot water inlet.

Saving

Reduces consumption of water and energy used for its warming.

Neo

Majestic and Elegant



Neo water taps feature robust elegance. You won't overlook a Neo tap in your bathroom - it is attractive and will elegantly complement all other bathroom accessories.



Easy way of scale removal.



Ceramic cartridge with 40 mm diameter is tested tested for a minimum life of 30 years.



Neo water taps are covered by a 5 year warranty.

Neo Water Taps



Washbasin standing tap
without waste
NO 012.00



Washbasin standing tap
with waste
NO 011.00



Bidet standing tap
with waste
NO 055.00



Wall-mounted bath tap
without set
150 mm
NO 022.00/150



Wall-mounted shower tap
without set
150 mm
NO 032.00/150



**Built-in
Built-in tap**
with diverter
NO 061.00



**Built-in
Shower tap**
without diverter
NO 062.00



**Built-in
Built-in tap**
with diverter
NO 065.00 - for R-box



**Built-in
Shower tap**
without diverter
NO 066.00 - for R-box



Built-in taps will enhance the sleek and stylish look of your bathroom.

The built-in tap with diverter directs the flow of water to two different places - either to the bath and shower, or to the hand and head shower.

Ergonomic diverter

Practical shape of the diverter allows its operation with wet hand.

Locking of the switch - bath / shower

The switch does not go off with a pressure drop.

Rosa

Natural Beauty

Rosa water taps are part of the Rosa Concept. See pages 34 - 35.



The true beauty comes from nature. Neat and smooth lines, round edges and harmonious proportions. The Rosa taps are designed to elegantly complement your bathroom with their beautiful and pleasing shape.



Easy way of scale removal.



Ceramic cartridge with 40 mm diameter is tested tested for a minimum life of 30 years.



Rosa water taps are covered by a 5 year warranty.

Rosa Water Taps



Washbasin standing tap
without waste
RS 012.00



Washbasin standing tap
with waste
RS 011.00



Bidet standing tap
with waste
RS 055.00



Wall-mounted bath tap
without set
150 mm
RS 022.00/150



Waterfall bath filling
with set
RS 025.00



Wall-mounted shower tap
without set
150 mm
RS 032.00/150



Built-in Built-in tap
with diverter
RS 061.00



Built-in Shower tap
without diverter
RS 062.00



Built-in Built-in tap
with diverter
RS 065.00 - for R-box



Built-in Shower tap
without diverter
RS 066.00 - for R-box

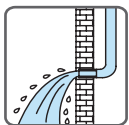

Flush the water pipes before installing the tap.
This will prevent soiling of the tap input sieve, extending its life.

For cleaning of water taps, use RAVAK Cleaner Chrome or other non-aggressive detergents in order to prevent damage to the chromium surface layer.



Rosa taps are part of the Rosa Concept.

Suzan

Simplicity, Tradition, Reliability



Simply well working, reliable water taps. Popular classic design of Suzan water taps fits each and every bathroom. They last long and nicely complement your washbasin, bath or shower enclosure.



All Suzan wall-mounted water taps have a 100mm and 150mm gauge.



Easy way of scale removal.



All Suzan water taps feature a 35 mm diameter ceramic cartridge with 5 years warranty.

Susan Water Taps



Washbasin standing tap
without waste
SN 012.00



Washbasin standing tap
with waste
SN 011.00



Washbasin standing tap
with 150 mm rotary spout
without waste
SN 015.00



Sink standing tap
with 230 mm rotary spout
without waste
SN 016.00



Wall-mounted bath tap
without set
150 mm
SN 022.00/150



Wall-mounted bath tap
without set
100 mm
SN 022.00/100



Wall-mounted shower tap
without set
150 mm
SN 032.00/150



Wall-mounted shower tap
without set
100 mm
SN 032.00/100



Wall-mounted washbasin / sink tap
with a 250mm rotary spout
150 mm
SN 041.00/150



Wall-mounted washbasin / sink tap
with a 250mm rotary spout
100 mm
SN 041.00/100



We recommend using a filtration system at the inlet pipe to the apartment/house. It will prolong not only the working life of the water tap, but also a washing machine or a dishwasher.



Can be controlled with one finger
A useful projection on the bottom of the lever for ease of control.



Showers

Long-term Pleasure and Delight

The beautiful design which adds an aesthetic value to your shower as well as ensuring durability of the whole mechanism, long life, lower water consumption, easy cleaning and maintenance.



SoftRain is a technology which allows air to be sucked automatically into the shower head, thus saving water consumption. Moreover, the stream of water enhanced with air bubbles makes the showering experience even more relaxing.



For cleaning of water taps, use RAVAK Cleaner Chrome or other non-aggressive detergents in order to prevent damage to the chromium surface layer.



Function for simple cleaning of small shower nozzles. Limescale formed on the jets can be simply wiped off with a gentle touch of your hand.

Showers

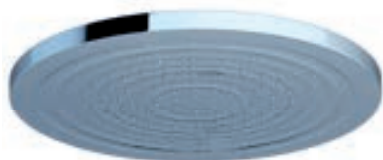

**Shower head - round
(brass)**
300 mm
980.00

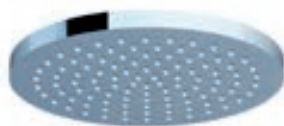

**Shower head - round
(brass)**
200 mm
981.00



New
**Shower head
Slim, Chrome**
square 300 mm,
982.00



**Side outlet arm
for the type 980.00,
981.00 and 982.00**
702.00



**Ceiling outlet arm
for the type 980.00, 981.00
and 982.00**
703.00
arm length 20 cm
704.00
arm length 30 cm
705.00
arm length 50 cm



**Shower head
5 modes**
diameter 108 mm
952.00



**Shower head
3 modes**
diameter 118 mm
953.00



New
**Shower head Fog
3 modes**
diameter 120 mm
956.00



New
**Shower head
Chrome
1 mode**
957.00



**Shower head
Oval Mini
1 mode**
Consumption 6.5 l per
minute
954.00



New
**Shower
column,
sliding**
DS 090.00



**Set - hose
150 cm,
shower head,
small holder**
diameter 68 mm
901.00



**Set - hose
of durable plastic 150 cm, flat
shower head with 3 modes,
bar with sliding shower holder,
70 cm**
902.00

Note: New products will be available from 03/2015.

Accessories

High-quality materials and a long life

*Choose your accessories for the bath, shower,
built-in and thermostatic water taps.
Proven materials and a high-quality chromium layer ensure a long life.*



***EasyTwist function prevents the hose from kinking
by letting the shower head rotate freely.***



***To clean water taps, use RAVAK Cleaner Chrome
For cleaning of water taps, use RAVAK Cleaner Chrome or other non-aggressive detergents in order
to prevent damage to the chromium surface layer.***

Accessories



Shower hose
150 cm
single-lock
911.00



Shower hose
150 cm
durable plastic
912.50



Shower hose
150 cm
durable plastic
913.00



Wall-mounted shower outlet
701.00



Bras shower holder with water outlet
706.00



Plastic shower holder
610.00



New
Shower holder adjustable, Chrome, with a joint
611.00



Bar with a sliding shower holder, 60 cm long
972.00



New
Bar with a sliding shower holder, Chrome 70 cm
974.00



Bar with sliding shower holder, 90 cm long
973.00

The 90cm shower bar is ideal for families with children. Installed in a shower enclosure, it allows both adults and children to enjoy a comfortable shower.



Note: Product 611.00 will be available from 03/2015 and product 974.00 from 04/2015.

R-box

Basic unit for built-in taps

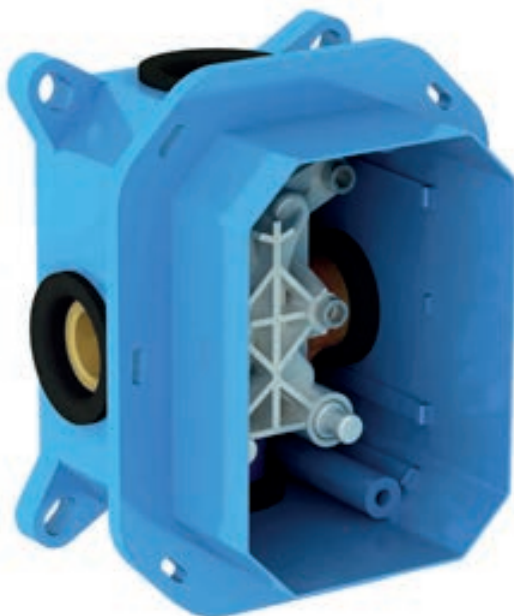

Basic unit for built-in taps

R-box
RB 070.50



R-box is a perfect, universal built-in system for lever, bath and shower built-in water taps. The tap's main body is made of high-quality brass. Unlike traditional built-in taps, the R-box installation is much easier and the potential exchange of the top part is simple. The top part of the R-box (Rosa, Neo, Chrome, a 10° taps numbered 065 and 066) is mounted after the bathroom has been completely finished, ensuring that the tap won't get scratched or damaged during final construction work.



Suitable for bath and shower built-in water taps (cannot be used for thermostatic water taps).



Developed for easy and quick installation

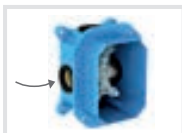

Compatible with all common piping systems (PPR, copper, plastic)



New

Built-in bath/shower tap 10°
with a diverter, - for R-box
TD 065.00



New

Built-in shower tap 10°
without diverter, - for R-box
TD 066.00



Chrome built-in bath/shower tap
with diverter, for R-box,
top part
CR 065.00



Chrome built-in shower tap
without diverter, for R-box,
top part
CR 066.00



Neo built-in bath/shower tap
with diverter, for R-box,
top part
NO 065.00



Neo built-in shower tap
without diverter, for R-box,
top part
NO 066.00



Rosa built-in bath/shower tap
with diverter, for R-box,
top part
RS 065.00



Rosa shower built-in tap
without diverter, for R-box,
top part
RS 066.00

The R-box enables very easy and quick installation. It offers various ways of mounting - into a plaster board or classic brick partition (dry and wet walling). It can be placed into a depth of 70 - 100 mm. The R-box contains wall fixings, it does not include connections for water pipes or any other plumbing materials.

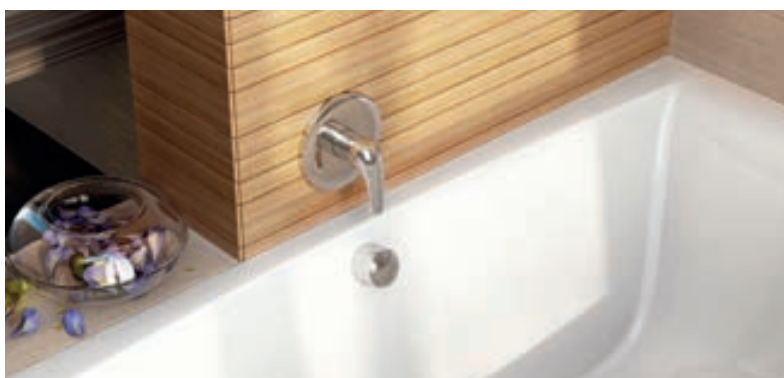

Note: New products will be available from 03/2015.

RAVAK AntiCalc® Technology



The best service comes directly from the manufacturer.

An invisible shield against grime and water deposits on glass

Each type of water (except for rain- and distilled water) always contains a certain amount of dissolved mineral salts. When these salts (the so-called limescale) deposit on glass, it can be very difficult to remove them. They create a chemical bond with the glass surface, giving the glass an unsightly tint. Common cleaning products are quite ineffective against limescale.

Only the **patented RAVAK AntiCalc® surface treatment technology** can reliably protect glass from stable sediments. All RAVAK shower enclosure and screen glass panels are treated with RAVAK AntiCalc® during manufacture.

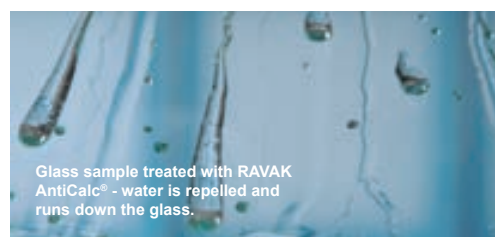

Glass sample treated with RAVAK AntiCalc® - water is repelled and runs down the glass.



Water effect on glass which was not treated with RAVAK AntiCalc®.

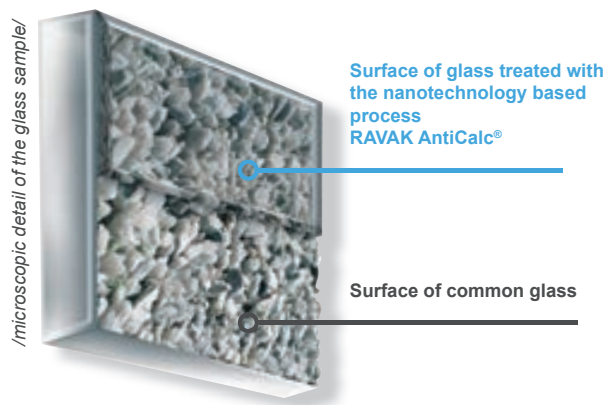

How to use RAVAK AntiCalc® Conditioner

First, clean the whole glass panel with a detergent (RAVAK Cleaner). Then apply the RAVAK Conditioner using a dry cloth on the inner side of the glass panel, which must be absolutely clean and dry. Spread the Conditioner evenly and polish the glass dry afterwards.

The water-repelling layer on the glass surface is renewed and for another 3 months (depending on the hardness of water) just clean the glass panels with a common detergent.

RAVAK Cleaning Detergents



RAVAK Cleaner Effectively cleans the whole bathroom

- Perfectly removes grease and remaining water deposits.
- Recommended for acrylic baths, shower trays, shower enclosure panels, but also for water taps, bathroom furniture and ceramic tiles.



RAVAK Cleaner Chrome For water taps

- Special detergent intended for removing grease and scale deposits from chromium-plated surfaces of water taps, accessories for water taps and chromium-plated surfaces of shower enclosures.



RAVAK AntiCalc® Conditioner Household helper in the fight against limescale

- You can renew the water-repellent qualities of our technology in your home conditions as well.
- We guarantee 10 years of perfect functioning of RAVAK AntiCalc® system if it is regularly renewed and correctly maintained with the AntiCalc® Conditioner.



RAVAK Desinfectant Helps get rid of bathroom mould

- A highly effective product of strong antiseptic character.
- Intended for the disinfection of all spots in the bathroom, where the mould and mildew thrive, mainly for surfaces of baths, shower trays, shower enclosures and hydro massage systems.

Use the biocidal RAVAK Desinfectant safely.
Read the instructions on the package and leaflet carefully before use.



RAVAK Turbo Cleaner Effectively cleans waste pipes

- Multi-effective detergent to dissolve even the heaviest grime sediments in waste pipes of baths, shower trays, and washbasins.
- Do not use for cleaning of products, especially of their metal parts.



RAVAK Teflon sanitary grease Invisibly lubricates

- Intended mainly for sliders and hinges of shower enclosures, doors and screens, cartridges, movable parts of water taps, door locks and handles.
- Water-resistant and highly effective - one droplet is enough.

Blue line of technical assistance

844 844 874



Blue line telephone rates
are according to local tariffs.

RAVAK a. s.
Obecnická 285, 261 01 Příbram 1
Czech Republic
tel.: 318 427 111, 318 427 200
fax: 318 427 269, 318 427 278
e-mail: info@ravak.cz

www.ravak.com



The manufacturer reserves the right to make technical changes in individual products, design and packaging of the product and changes in prices. The manufacturer is not responsible for any print errors, should they occur.



RAVAK®